

SCOTTISHPOWER
RENEWABLES

East Anglia TWO Offshore Windfarm

Outline Access Management Plan

Applicant: East Anglia TWO Limited

Document Reference: 8.10 Tracked

SPR Reference: EA2-DWF-ENV-REP-IBR-000944 Rev 054

Author: Royal HaskoningDHV

Date: ~~125th March~~ April 2021

Revision: Version 054

Applicable to
East Anglia TWO



Revision Summary

| Rev | Date | Prepared by | Checked by | Approved by |
|-----------|-------------------|-----------------------|------------------------|--------------------|
| 001 | 08/10/2019 | Paolo Pizzolla | Julia Bolton | Helen Walker |
| 002 | 15/12/2020 | Paolo Pizzolla | Lesley Jamieson | Rich Morris |
| 003 | 24/02/2021 | Paolo Pizzolla | Lesley Jamieson | Rich Morris |
| 004 | 25/03/2021 | Paolo Pizzolla | Lesley Jamieson | Rich Morris |
| <u>05</u> | <u>15/04/2021</u> | <u>Paolo Pizzolla</u> | <u>Lesley Jamieson</u> | <u>Rich Morris</u> |

Description of Revisions

| Rev | Page | Section | Description |
|-----------|------------|------------|---|
| 001 | n/a | n/a | Final for Submission |
| 002 | n/a | n/a | Updated for submission at Deadline 3 |
| 003 | n/a | n/a | Updated for submission at Deadline 6 |
| 004 | n/a | n/a | Final for submission at Deadline 8 |
| <u>05</u> | <u>n/a</u> | <u>n/a</u> | <u>Final for submission at Deadline 9</u> |



Table of Contents

| | | |
|----------|--|-----------|
| 1 | Introduction | 1 |
| 1.1 | Background | 1 |
| 1.2 | OAMP Scope | 2 |
| 1.3 | Planning Performance Agreement | 3 |
| 2 | Access Design | 5 |
| 2.1 | Access Strategy | 5 |
| 2.2 | Access Design | 9 |
| 2.3 | Crossing Design | 13 |
| 2.4 | Road Safety | 14 |
| 2.5 | Technical Approval | 15 |
| 3 | Traffic Management | 17 |
| 3.1 | Traffic Management – Road Works | 17 |
| 3.2 | Traffic Management – Sizewell Gap | 19 |
| 3.3 | Onshore Preparation Works Traffic Controls | 20 |
| 3.4 | Access 13 Operational Traffic Controls | 22 |
| 4 | References | 23 |
| | Annex 1: Suffolk – Lorry Route Network (extract) | |
| | Annex 2: Proposed Preliminary Access Concepts | |
| | Annex 3: Stage 1 Road Safety Audit and Designers Response | |



The Outline Access Management Plan is supported by one figure, listed in the table below.

| Figure number | Title |
|---------------|--|
| Figure 1 | Access Locations and Associated Onshore Infrastructure |



Glossary of Acronyms

| | |
|---------|--|
| AIL | Abnormal Indivisible Load |
| CCS | Construction Consolidation Site |
| DCO | Development Consent Order |
| DMRB | Design Manual for Roads and Bridges |
| ES | Environmental Statement |
| HDD | Horizontal Directional Drill |
| HGV | Heavy Goods Vehicle |
| OAMP | Outline Access Management Plan |
| OTP | Outline Travel Plan |
| OCTMP | Outline Construction Traffic Management Plan |
| OPCTMTP | Outline Port Construction Traffic Management and Travel Plan |
| RSA | Road Safety Audit |



Glossary of Terminology

| | |
|---------------------------------------|--|
| Applicant | East Anglia TWO Limited. |
| Construction consolidation sites | Compounds associated with the onshore works which may include elements such as hard standings, lay down and storage areas for construction materials and equipment, areas for vehicular parking, welfare facilities, wheel washing facilities, workshop facilities and temporary fencing or other means of enclosure. |
| Contractor | An individual or business in charge of carrying out construction work. |
| East Anglia TWO project | The proposed project consisting of up to 75 wind turbines, up to four offshore electrical platforms, up to one construction, operation and maintenance platform, inter-array cables, platform link cables, up to one operational meteorological mast, up to two offshore export cables, fibre optic cables, landfall infrastructure, onshore cables and ducts, onshore substation, and National Grid infrastructure. |
| Horizontal directional drilling (HDD) | A method of cable installation where the cable is drilled beneath a feature without the need for trenching. |
| Jointing bay | Underground structures constructed at intervals along the onshore cable route to join sections of cable and facilitate installation of the cables into the buried ducts. |
| Landfall | The area (from Mean Low Water Springs) where the offshore export cables would make contact with land, and connect to the onshore cables. |
| National Grid infrastructure | A National Grid substation, cable sealing end compounds, cable sealing end (with circuit breaker) compound, underground cabling and National Grid overhead line realignment works to facilitate connection to the national electricity grid, all of which will be consented as part of the proposed East Anglia TWO project Development Consent Order but will be National Grid owned assets. |
| National Grid substation | The substation (including all of the electrical equipment within it) necessary to connect the electricity generated by the proposed East Anglia TWO project to the national electricity grid which will be owned by National Grid but is being consented as part of the proposed East Anglia TWO project Development Consent Order. |
| Onshore cable route | This is the construction swathe within the onshore cable corridor which would contain onshore cables as well as temporary ground required for construction which includes cable trenches, haul road and spoil storage areas. |
| Onshore cables | The cables which would bring electricity from landfall to the onshore substation. The onshore cable is comprised of up to six power cables (which may be laid directly within a trench, or laid in cable ducts or protective covers), up to two fibre optic cables and up to two distributed temperature sensing cables. |
| Onshore infrastructure | The combined name for all of the onshore infrastructure associated with the proposed East Anglia TWO project from landfall to the connection to the national electricity grid. |



| | |
|---------------------------|--|
| Onshore preparation works | Activities to be undertaken prior to formal commencement of onshore construction such as pre-planting of landscaping works, archaeological investigations, environmental and engineering surveys, diversion and laying of services, and highway alterations. |
| Onshore substation | The East Anglia TWO substation and all of the electrical equipment within the onshore substation and connecting to the National Grid infrastructure. |
| Transition bay | Underground structures at the landfall that house the joints between the offshore export cables and the onshore cables. |



Outline Access Management Plan

1 Introduction

1.1 Background

1. This Outline Access Management Plan (OAMP) relates to the onshore infrastructure of the proposed East Anglia TWO project.
2. The OAMP forms part of a set of documents that supports the Environmental Statement (ES) (document reference 6.1) submitted by the Applicant as part of the Development Consent Order (DCO) application.
3. A final detailed Access Management Plan (AMP) will be produced post-consent, prior to onshore construction of the proposed East Anglia TWO project and will be in line with this OAMP. Once contractors¹ have been appointed, the final AMP measures would be further developed in consultation with Suffolk County Council (as the Local Highway Authority).
4. Prior to the commencement of works, the final AMP would need to be approved by Suffolk County Council (SCC) in consultation with the relevant planning authority.
5. EDF Energy Nuclear Generation Limited will be consulted in the development of the final CTMP to the extent that the plan relates to Works Nos. 10 and 15.
6. The final AMP will provide a key mechanism, enforceable through the DCO, through which the location, frontage, general layout, visibility and embedded mitigation measures for points of access to the onshore infrastructure would be agreed with the relevant regulators.
7. This OAMP reinforces commitments made in the ES (document reference 6.1) and presents the requirements and standards that will be incorporated into the final access designs.
8. In respect to traffic and transport, the certified plans referred to in the DCO, which support the AMP, are outlined below:

¹ The term contractor is used throughout this document. The term 'contractor' in relation to contractor responsibilities relates to either a Principal Contractor(s) or sub-contractors(s) and will be defined within the final OAMP.



- Outline Construction Traffic Management Plan (OCTMP): The OCTMP sets out the standards and procedures for managing the impact of Heavy Goods Vehicle (HGV) traffic during the construction period, including localised road improvements necessary to facilitate the safe use of the existing road network;
- Outline Travel Plan (OTP): The OTP sets out how construction personnel traffic would be managed and controlled; and
- Outline Port Construction Traffic Management and Travel Plan (OPCTMTP): The OPCTMTP serves to capture a framework of measures and commitments to manage the port construction and operation traffic generated by the offshore development area. The port locations are to be determined and the need for these plans will be established in consultation with the relevant planning authority for the selected construction port(s) or operation port(s).

1.2 OAMP Scope

9. Activities within the scope of this OAMP relate to works undertaken from the point of commencement of the onshore preparation works of the proposed East Anglia TWO project. Onshore infrastructure as defined within the DCO or as permitted as onshore preparation works in line with the provisions set out within the DCO include:
 - Export cable installation from the landfall location to the transition bays, including Horizontal Directional Drilling (HDD);
 - Temporary works associated with landfall HDD and transition bay excavation;
 - Onshore cable installation along the onshore cable route including jointing bays and potential HDD;
 - Temporary works associated with the onshore cable route and onshore substation including establishment of a haul road for the entire cable route, Construction Consolidation Sites (CCSs) and temporary working areas;
 - Onshore substation, and access;
 - National Grid infrastructure;
 - Reinstatement and mitigation works enacted during the construction phase; and
 - Highways enabling works include the construction of five public highway accesses, four haul road crossings and off-site highway improvements.
10. The East Anglia ONE North project is also in the Examination phase. The East Anglia ONE North project has a separate DCO which has been submitted at the same time as the East Anglia TWO project. The two projects share the same



landfall location and onshore cable route and the two onshore substations are co-located, and connect into the same National Grid substation.

11. The traffic and transport impact assessment presented in the ES considers the proposed East Anglia TWO project and the proposed East Anglia ONE North project under two construction scenarios:
 - Scenario 1 - the proposed East Anglia TWO project and proposed East Anglia ONE North project are built simultaneously; and
 - Scenario 2 - the proposed East Anglia TWO project and the proposed East Anglia ONE North project are built sequentially with a construction gap.
12. The scope of this OAMP applies to both scenario 1 and scenario 2.

1.3 Planning Performance Agreement

13. The Applicant will not undertake any works to any highway or highway asset that is the responsibility of SCC until a Planning Performance Agreement (PPA) has been agreed with SCC (both parties acting reasonably and in good faith) which will allow SCC to recover reasonable costs including but not limited to: The Applicants have agreed to enter into a Planning Performance Agreement (PPA) with SCC. The PPA will allow SCC to recover reasonable costs for activities including but not limited to the following:

- Additional costs of routine, cyclic and emergency highway maintenance resulting from the Applicants' occupation or use of the highway²;
- Visual and structural condition surveys of the highway (A1094, B1069, B1122, Lovers Lane, Sizewell Gap and parts of A12) and contributions towards structural repairs;
- Surveys and assessment of highway structures to facilitate AIL movements;
- Damage to the highway (in accordance with the provisions of Section 59 Highways Act 1980);
- Creation of temporary traffic regulation orders (including SCC consultation and issue of permits);
- Relocating / removing street furniture and all other highway infrastructure to facilitate AIL movements;
- Technical approval and inspection of highway accesses (Requirement 16), Work No 35, Work No 37, Church Road Friston traffic management and cable

² This could include activities on delivery routes such as clearing visibility splays on critical junctions, refreshing road markings and sign cleaning that would be in addition to SCCs cyclic maintenance regimes.



crossings as detailed in the approved Construction Traffic Management Plan;
and

- Review of submitted materials for monitoring the final management plans (such as CTMP/ Travel Plan / PRow Strategy etc).

14. In undertaking works on the public highway, the Applicants shall ensure through appropriate agreements and approvals that:

- The areas of the public highway occupied pursuant to Articles 12, 13 or 15 of the DCO are maintained to the standards defined in SCC's Highway Operational Management Plan (SCC, July 2019) (taking account of the category of highway asset) during that period of occupation.
- The Applicants shall ensure that the periods and physical extents of occupation are defined, and that SCC is protected against third party claims caused by the Applicants' occupation of the public highway pursuant to Article 12, 13 or 15 of the DCO.
- In seeking to temporarily stop up, alter, divert or use as a temporary working site a street to which Article 12(5)(c) of the DCO applies, the Applicants shall allow a reasonable advance notice period in line with *the New Roads and Street Works Act* (Department for Transport 1991) and *the Statutory Guidance for highway authority permit schemes* (Department for Transport 2019), which directs three months' notice for Major Works, 10 days for Standard Works and three days for Minor Works).
- Notwithstanding the above, SCC is not unreasonably refused access to inspect or maintain the highway in accordance with its duties under the Highways Act 1980.

15. Any dispute or difference arising in connection with the terms of the proposed PPA between the Applicant and SCC, shall be referred to arbitration in accordance with Article 37 of the draft DCO.



2 Access Design

2.1 Access Strategy

~~15-16.~~ The onshore infrastructure includes works at the following seven discrete sites (which are shown on **Figure 1** of this OAMP):

- Landfall location;
- Onshore cable route section 1;
- Onshore cable route section 2;
- Onshore cable route section 3;
- Onshore cable route section 4;
- Onshore substation; and
- National Grid Infrastructure.

~~16-17.~~ In order to access these seven discrete sites an access strategy has been developed. The ‘basis of design’ for the access strategy has been informed by engagement with SCC and refined following feedback from public consultation (full details are set out in ES **Chapter 26 Traffic and Transport** (document reference 6.1.26)).

~~17-18.~~ The access strategy applies a hierarchical approach (informed by the SCC HGV route hierarchy) to selecting routes and where possible, seeks to reduce the impact of HGV traffic upon the most sensitive communities. A copy of the SCC HGV route hierarchy plan is provided in **Annex 1 Suffolk – Lorry Route Network (extract)**.

~~18-19.~~ To allow construction vehicles to be routed away from the most sensitive communities, the Applicant has committed to the implementation of a temporary haul road for the length of onshore cable route. The use of the haul road allows:

- All construction traffic wishing to access the landfall location to do so via Sizewell Gap rather than travelling via the B1122 from Aldeburgh and B1353 towards Thorpeness;
- All construction traffic to the onshore substation and National Grid Substation to avoid travelling via Friston or Sternfield by accessing from the B1069 (south of Knodishall/ Coldfair Green) and travelling along the temporary haul road and crossing over Grove Road; and
- All construction traffic wishing to access all onshore cable route section 2 to the south of the B1353 to do so via Sizewell Gap rather than travelling via the B1122 from Aldeburgh and B1353 towards Thorpeness.



~~19.20.~~ The use of the haul route has allowed the Applicant to commit the following access strategy:

- All HGV traffic would be required to travel via the A1094 or B1122 from the A12, no HGV traffic would be permitted to travel via alternative routes, such as the B1121 or B1119;
- No HGV traffic would be permitted to travel though Leiston or Coldfair Green / Knodishall;
- No HGV traffic would be permitted to travel via the B1121 through Friston, Sternfield or Benhall-Green; and
- No HGV traffic would be permitted to travel via the B1353 towards Thorpeness.

~~20.21.~~ The access strategy includes both accesses and crossings. The accesses provide for access and egress to and from the existing public highway, whilst crossings would only permit construction traffic to cross from one side of the existing public highway to the other. No construction access or egress would be permitted from the crossing points.

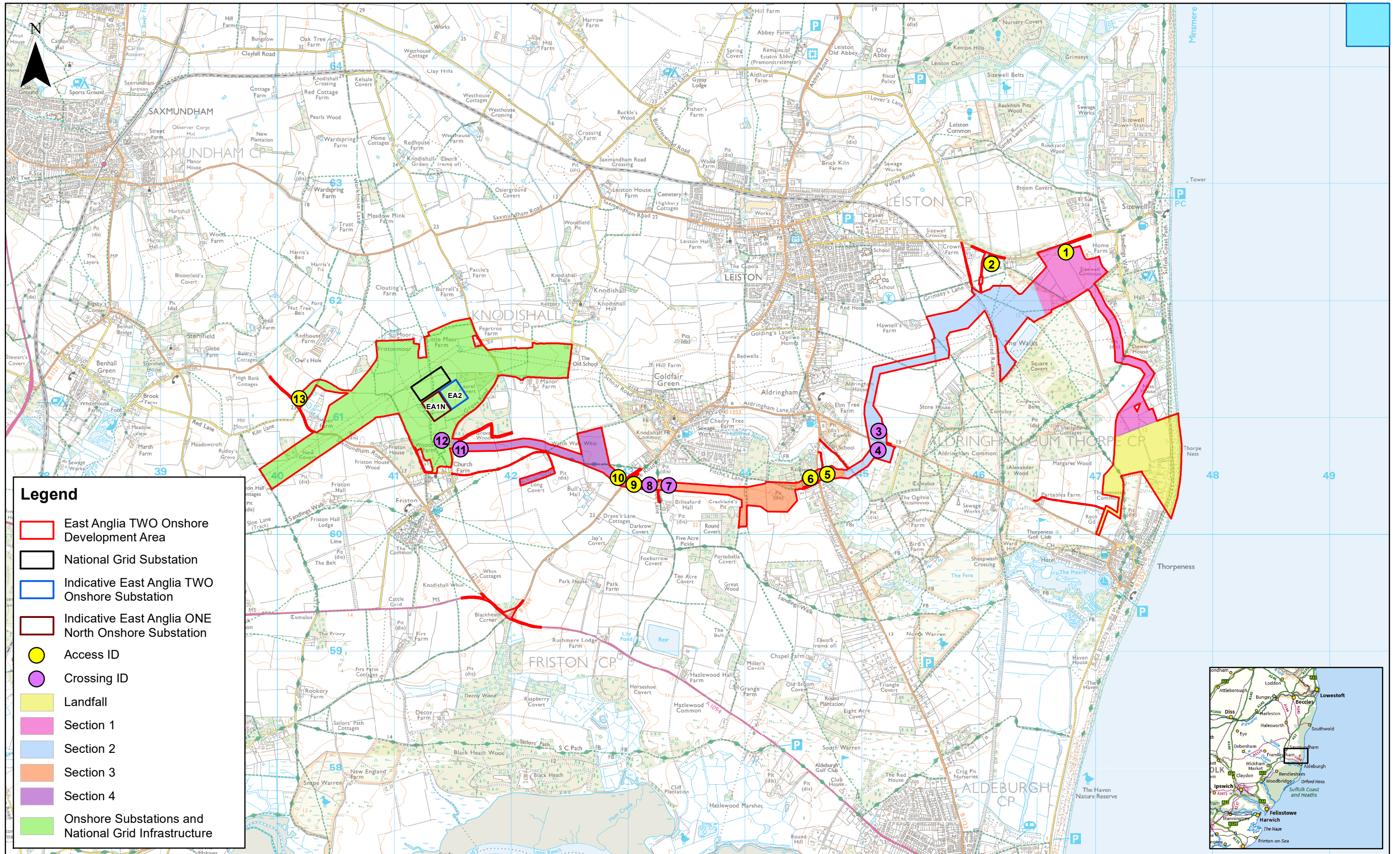

Legend

- East Anglia T2O Onshore Development Area
- National Grid Substation
- Indicative East Anglia T2O Onshore Substation
- Indicative East Anglia ONE North Onshore Substation
- Access ID
- Crossing ID
- Landfall
- Section 1
- Section 2
- Section 3
- Section 4
- Onshore Substations and National Grid Infrastructure



| | | | | | |
|------------|-------------|-----------|----------------|------------------|-----------|
| 3 | 14/12/2020 | AB | Third Issue. | | |
| 2 | 04/09/2019 | AB | Second Issue. | Prepared: | AB |
| 1 | 20/06/2019 | AB | First Issue. | Checked: | BD |
| Rev | Date | By | Comment | Approved: | FM |

1:30,000
Scale @ A3

0 0.5 1 Km

Source: © Crown copyright and database rights 2019. Ordnance Survey 0 10003 1673.
This map has been produced to the latest known information at the time of issue, and has been produced for your information only. Please consult with the SPR Onshore GIS team to ensure the content is still current before using the information contained on this map. To the fullest extent permitted by law, we accept no responsibility or liability (whether in contract, tort (including negligence) or otherwise in respect of any errors or omissions in the information contained in the map and shall not be liable for any loss, damage or expense caused by such errors or omissions.

East Anglia T2O

Access Locations and Associated Onshore Infrastructure

| | | |
|---------------|------------------------|------------------------|
| Drg No | EA2-DEV-DRG-IBR-000741 | |
| Rev | 3 | Coordinate System: BNG |
| Date | 14/12/20 | Datum: OSG36 |
| Figure | 1 | |



~~21-22.~~ The following **Table 2.1** describes the proposed access strategy, the location of the proposed accesses and crossings and associated onshore infrastructure which the access serves. This information is also depicted graphically within **Figure 1**.

Table 2.1 Proposed East Anglia TWO Accesses and Associated Infrastructure Components

| Infrastructure component | Access | Route |
|---|----------------------------|--|
| Landfall | 1 (Sizewell Gap) | Vehicles to travel from the A12 via the B1122 and Lover's Lane / Sizewell Gap. |
| Onshore cable route section 1 | 1 (Sizewell Gap) | Vehicles to travel from the A12 via the B1122 and Lover's Lane / Sizewell Gap. |
| Onshore cable route section 2 | 2 (Sizewell Gap) | Vehicles to travel from the A12 via the B1122 and Lover's Lane / Sizewell Gap. Vehicles wishing to access south of B1353 would cross the B1353 at access 3 and 4. |
| Onshore cable route section 3 | 10 (B1069 Snape Road) | Vehicles to travel from the A12 via the A1094 before heading north on the B1069 to the CCS via access 10. From the CCS vehicles would then cross over the B1069 from access 10 to 9 to access section 3 of the onshore cable route. Works to the east of Sloe Lane to the B1122 would cross Sloe Lane at access 7 and 8. Works to the east of the B1122 to the Hundred River would cross the B1122 at access 5 and 6. |
| Onshore cable route section 4 | 10 (B1069 Snape Road) | Vehicles to travel from the A12 via the A1094 before heading north to access 10 on the B1069. Works to the west of Grove Road would cross Grove Road at access 11 and 12. |
| East Anglia TWO Substation | 10 (B1069 Snape Road) | Vehicles to travel from the A12 via the A1094 before heading north to access 10 on the B1069, vehicles would then travel via the haul road and crossing Grove Road at access 11 and 12. |
| National Grid Substation and Infrastructure | | |
| East Anglia TWO Substation | 13 (B1121 Saxmundham Road) | Access 13 would provide a permanent access to the East Anglia TWO and National Grid substations following completion of construction. During construction the access would only be used for Abnormal Indivisible Load (AIL) deliveries associated with the delivery of transformers and National Grid employees. |
| National Grid Substation and Infrastructure | | |

~~22-23.~~ There is a small part of section 3 of the onshore cable route (section 3B) that is located either side of the B1122 to the south of Aldringham (**Figure 1**).

~~23-24.~~ HGV demand through the Aldeburgh junction accessing section 3B (westward of the Hundred River) would be limited to a maximum of 10 movements per day at



times where the temporary haul road from access 9 (located off the B1069) is not available. Vehicles would travel east along the temporary haul road to reach section 3B (westward of the Hundred River). To reach the part of section 3B located east of the B1122 and west of the Hundred River, vehicles would cross over the road at a signalised crossing. No construction traffic would be permitted to access or egress from access 5 and 6 when the temporary haul road from access 9 is available.

~~24-25.~~ At times when the temporary haul road is not available, Temporary, part-time four-way signals would be employed at accesses 5 and 6 to eliminate vehicle conflicts.

~~25-26.~~ No deliveries will be permitted via the B1122 when the haul road from access 9 to section 3B is available and accesses 5 and 6 would be converted to a signal controlled crossing with the B1122 signals resting on green. The OCTMP provides further details of how HGV movements would be managed through Aldeburgh.

~~26-27.~~ After construction, temporary accesses (access 1 to 12) will be reinstated, unless otherwise agreed with SCC and relevant landowner.

~~27-28.~~ Access 13 would provide a permanent access to the onshore substation and National Grid substation and would therefore remain for the operational life of the proposed East Anglia TWO project. It is anticipated that the proposed East Anglia ONE North project would use access 13 as permanent access to the East Anglia ONE North onshore substation.

2.2 Access Design

~~28-29.~~ Accesses 1, 2, 9, 10 and 13 have been designed as simple priority junctions, with geometry in accordance with the requirements of the Design Manual for Roads and Bridges (DMRB) standards for major/ minor priority junctions.

~~29-30.~~ Accesses 5 and 6 would only be used at times when the temporary haul road is not available from access 9). The Applicant has therefore sought to reduce the footprint of these accesses through the use of temporary, part-time traffic signal control. This strategy allows the accesses to have a smaller footprint (as vehicles can sweep out into the oncoming lane to make the turns in and out without conflicting) and facilitates quicker conversion to a crossing.

~~30-31.~~ General arrangement drawings (with details of visibility splays, signage and road markings), of all accesses are provided in **Annex 2**.

~~31-32.~~ In order to ensure that HGVs can enter and exit each access in forward gear, swept path analysis has been undertaken for each access. This swept path



analysis (presented within **Annex 2**) has been undertaken using a maximum legal articulated vehicle and a rigid body tipper. These vehicle types are considered to provide a representation of the largest standard vehicles that would use the accesses.

~~32-33~~. The ES identifies that the construction of the onshore substation would require the delivery of up to two transformers for the proposed East Anglia TWO project. Each transformer delivery would be classified as a Special Order³ Abnormal Indivisible Load (AIL) delivery due to the size of the vehicle and would access via access 13.

~~33-34~~. Access 13 (presented within **Annex 2**) has therefore been designed to encompass an overrun area to allow the AIL deliveries to turn from the B1121 into Access 13.

~~34-35~~. There would also be a requirement for abnormal load movements associated with the delivery of plant and cable drums to accesses, 1, 2, 9 and 10. The accesses have been designed such that these abnormal loads can access and egress, albeit the vehicle may need to straddle both entry and exit lanes under pilot vehicle escort. The Onshore Preparation Works Management Plan will contain a method statement for how these movements are safely managed.

~~35-36~~. A summary of the drawings provided within **Annex 2** and content are provided in **Table 2.2**.

Table 2.2 Access Design Drawing Summary

| Access ID | General Arrangement drawing | Swept path analysis drawings |
|---|-----------------------------|--|
| 1 | TP-PB4842-DR001 Rev D0.6 | TP-PB4842-DR002 Rev D0.3 |
| 2 | TP-PB4842-DR003 Rev D0.4 | TP-PB4842-DR004 Rev D0.3 |
| 5 and 6 | TP-PB4842-DR008 Rev D0.7 | TP-PB4842-DR009 Rev D0.4 and TP-PB4842-DR010 Rev D0.4 |
| 9 | TP-PB4842-DR011 Rev D0.5 | TP-PB4842-DR012 Rev D0.4 |
| 10 | TP-PB4842-DR011 Rev D0.5 | TP-PB4842-DR013 Rev D0.4 |
| 13 (construction phase for AILs and National Grid employees only) | TP-PB4842-DR020 Rev D0.3 | TP-PB4842-DR022 Rev D0.3 |
| 13 (operational phase) | TP-PB4842-DR021 Rev D0.3 | TP-PB4842-DR022 Rev D0.3 |

³ The Road Vehicles (Authorisation of Special Types) (General) Order 2003 (SI 1998) limits gross weight of an AIL to 150 tonnes, axle weight to 16,500kg, length to 30m and/or width to 6.1m, above which a Special Order is required from Highways England.



~~36-37.~~ The general guiding principle for the access design is to keep engineering works to a minimum to reduce the environmental impact of the proposed East Anglia TWO project and ensure timely reinstatement of baseline conditions. This has entailed minimising vegetation that needs to be removed to provide forward visibility.

~~37-38.~~ **Table 2.3** provides a summary of the required visibility splay for each access in accordance with the measured 85th percentile speeds (the speed at which 85 percent of all vehicles are observed to travel) and the achievable splays. It has been agreed with SCC that 85th percentile speeds should be used rather than average speeds as this would provide a worst case for determining visibility splays as higher speeds result in a requirement for longer visibility splays.

~~38-39.~~ Where the visibility splays cannot be achieved, measures are proposed to temporarily reduce the speed limit and consequently the required visibility splay.

Table 2.3 Access Visibility Requirements

| Access ID * | Measured 85th percentile speeds (mph) | Required visibility for 85th percentile speed | Achievable visibility | Visibility achievable | Further traffic control measures | Notes | |
|-------------|---------------------------------------|---|-----------------------|-----------------------|----------------------------------|---|--|
| 1 | 57.1 | 215m | 380m | 295m | Yes | Temporary reduction in the speed limit from 60 to 40mph | Whilst visibility is achievable, a reduction in speed limit is proposed as best practice. |
| 2 | 57.1 | 215m | 195m | 215m | No | Temporary reduction in the speed limit from 60 to 40mph | The visibility to the east is 20m shorter than required for a design speed of 100kph (62.5mph). It is therefore proposed to temporarily reduce the speed limit to 40mph. |
| 5 ** | 44.7 | 120m | 120m | 120m | Yes | Speed limit | Whilst forward |



| Access ID * | Measured 85th percentile speeds (mph) | Required visibility for 85th percentile speed | Achievable visibility | Visibility achievable | Further traffic control measures | Notes |
|-------------|---------------------------------------|---|-----------------------|-----------------------|----------------------------------|--|
| | | | | | reduced from 40 to 30mph | visibility to the signal heads is achievable, a reduction in speed limit is proposed as best practice. |
| 6 ** | 44.7 | 120m | 120m | 120m | Yes | Speed limit reduced from 40 to 30mph Whilst forward visibility to the signal heads is achievable, a reduction in speed limit is proposed as best practice. |
| 9 | 39.4 | 120m | 50m | 95m | No | Extension of the existing 40mph speed limit south along the B1069. It is proposed to extend the existing 40mph speed limit further south along to reduce the speed of vehicles on the approach to access 9. In addition, existing vegetation will be removed/ cut back to ensure a visibility splay of 120m can be achieved in both directions. |
| 10 | 39.4 | 120m | 120m | 268m | Yes | Extension of the existing 40mph Whilst visibility is achievable, an extension |



| Access ID * | Measured 85th percentile speeds (mph) | Required visibility for 85th percentile speed | Achievable visibility | Visibility achievable | Further traffic control measures | Notes |
|--|---------------------------------------|---|-----------------------|-----------------------|------------------------------------|---|
| | | | | | speed limit south along the B1069. | of the the 40mph speed limit is required for access 9 located opposite access 10 on the B1069. |
| 13 | 43.8 | 160m | 247m | 161m | Yes | Temporary reduction in the speed limit from 60 to 40mph Speed limit reduction to be applied for construction only. Upon completion of the construction the temporary speed limit would be removed. |
| Notes: * Accesses 3, 4, 7, 8, 11 and 12 are considered separately in Section 2.3 because at these locations construction traffic would only be able cross the public highway. ** Visibility for accesses 5 and 6 is quoted as the forward visibility to the traffic signal head | | | | | | |

2.3 Crossing Design

~~39.~~40. Where the haul road crosses the public highway at the B1353 (access 3 and 4), B1122 (access 5 and 6), Sloe Lane (access 7 and 8) and Grove Road (access 11 and 12), formalised crossings are proposed.

~~40.~~41. The crossing points at Grove Road and Sloe Lane are located at sections of the highway where existing traffic flows and speeds are low. It is proposed therefore that construction vehicles would give-way to traffic on the public highway and cross in gaps in traffic when safe to do so.

~~41.~~42. The crossing points at the B1353 and B1122 are located at sections of the highway where traffic flows and speeds are higher, it is therefore proposed that construction vehicles cross the public highway under traffic signal control. Under



traffic signal control, the traffic signals would rest on red on the haul road and would only change to green when demanded by vehicles on the haul road.

~~42.~~43. Each of the crossings have been designed to ensure that vehicles cannot turn off or on to the public highway from the haul road. To prevent dirt being tracked across the public highway at least 20m of carriageway construction (concrete or asphalt) are provided either side of the entry point. Further measures to prevent dirt being tracked across the public highway are detailed within the Outline Code of Construction Practice (OCocP) submitted with the DCO application.

~~43.~~44. General Arrangement drawings (with details of signs, road markings and visibility drawings are provided in **Annex 2** and a summary of the drawings and content are provided in **Table 2.4**.

Table 2.4 Crossing Design Drawing Summary

| Access ID | General Arrangement drawing |
|-----------|-----------------------------|
| 3 and 4 | TP-PB4842-DR007 Rev D0.4 |
| 5 and 6 | TP-PB4842-DR030 Rev D0.1 |
| 7 and 8 | TP-PB4842-DR027 Rev D0.1 |
| 11 and 12 | TP-PB4842-DR014 Rev D0.3 |

2.4 Road Safety

~~44.~~45. The following mitigation measures have been developed to reduce the risk to the travelling public and construction personnel and are applied to each access and crossing (where applicable):

- Temporary direction and warning signs to advise of turning vehicles would be provided for all accesses. This signage would highlight the proposed accesses to construction personnel traffic to avoid late breaking manoeuvres and highlight to the travelling public the potential for turning vehicles;
- Temporary warning signs to advise of crossing vehicles would be provided for all crossings. This signage would highlight to the travelling public the potential for crossing vehicles;
- All accesses constructed to facilitate two-way HGV movements to prevent vehicles having to give way on the highway;
- All crossings constructed to prevent access from the highway, ensuring vehicles do not attempt to access or egress at these locations;
- All accesses and crossings provided with appropriate visibility splays to allow vehicles to safely access and exit from the junctions. These splays will be maintained by the Contractor for the duration of use of the access;



- All accesses and crossings to incorporate a bound (concrete or asphalt) surface to prevent dust and dirt being tracked on to the highway; and
- Temporary reduction in the existing speed limit in the vicinity of all accesses and crossings to reduce the speed of vehicles in the vicinity of these locations (all temporary speed restrictions will be raised by SCC using their statutory powers).

~~45-46.~~ In addition to the applied road safety measures, each access and crossing have been subject to an independent Stage 1 Road Safety Audit (RSA) (preliminary design). A copy of the independent Stage 1 RSA is provided within **Annex 3**.

~~46-47.~~ The Stage 1 RSA has identified a total of 10 problems⁴ with the access designs as presented and provides recommendations for how to address these problems as the designs are developed. A Designers response is also provided within **Annex 3** this includes confirmation of the acceptance of each of the problems and also the auditor's recommendations for how to address these problems.

2.5 Technical Approval

~~47-48.~~ Once a Contractor has been appointed, the technical approvals for the access, crossing designs and speed limit modifications will be submitted to and agreed with SCC in accordance with the provisions of DCO Requirement 16.

~~48-49.~~ The technical approval process will include submission of finalised drawings, showing full details of access and crossing improvements, including drainage, lighting, signing, and standard construction details.

~~49-50.~~ Apart from Access 13, all accesses and crossing points are temporary and following completion of construction would be reinstated to their former state unless otherwise agreed with SCC and the relevant landowner.

~~50-51.~~ All temporary speed limit changes associated with the access and crossing strategy will be implemented by SCC (at the Applicants cost) using their statutory powers.

2.5.1 Road Safety Audit

~~51-52.~~ The Applicant will comply with the RSA process (as outlined within the Design Manual for Roads and Bridges GG 119 (Highways England January 2020)) for all accesses and crossings. The RSA process comprises of a systematic process for the independent review of highway schemes. The purpose of the RSA process

⁴ The term 'problem' is a formal road safety audit term that identifies an issue with the design as present that need to be addressed.



is to minimise the future occurrences and severity of collisions once a scheme has been built.

~~52.53.~~ Stage 1 of the RSA process (Preliminary Design) has been completed and is detailed in **Annex 3**. As the Project lifecycle develops, the Applicant will apply the following three RSA stages:

- The technical approval documentation will include a Stage 2 RSA (detailed design) and designer's response. This stage will seek to identify and eliminate issues prior to the commencement of construction;
- A Stage 3 RSA (completion of construction) will be undertaken prior to, or just after opening and identify any issues requiring remedial works; and
- Stage 4 RSA (post opening monitoring) will be undertaken 12 months after opening and comprise of a review of the collision records (pre and post opening) to understand if there are emerging issues that could warrant intervention.



3 Traffic Management

~~53-54~~. In order to construct each of the accesses and crossings, temporary traffic management will be implemented to maintain highway safety and to ensure minimal delays to existing road users.

~~54-55~~. In addition, to minimise the impacts of construction traffic on the wider highway associated with the construction of the accesses and crossings, wider control measures proportionate to the scale of the proposed works are detailed below.

3.1 Traffic Management – Road Works

~~55-56~~. The form of traffic management to be employed at each access and crossing location depends on the characteristics at the site (traffic volume, speed, visibility etc). In locations where traffic flows are very low and forward visibility is good, shuttle working could be controlled manually with the use of STOP/GO signs. In most cases however, it is expected that alternate one-way traffic (shuttle working) would be traffic signal controlled. Indicative working arrangements extracted from Safety at Street Works and Road Works: a code of practice 2013, are shown in **Plate 3.1 - Plate 3.3**.

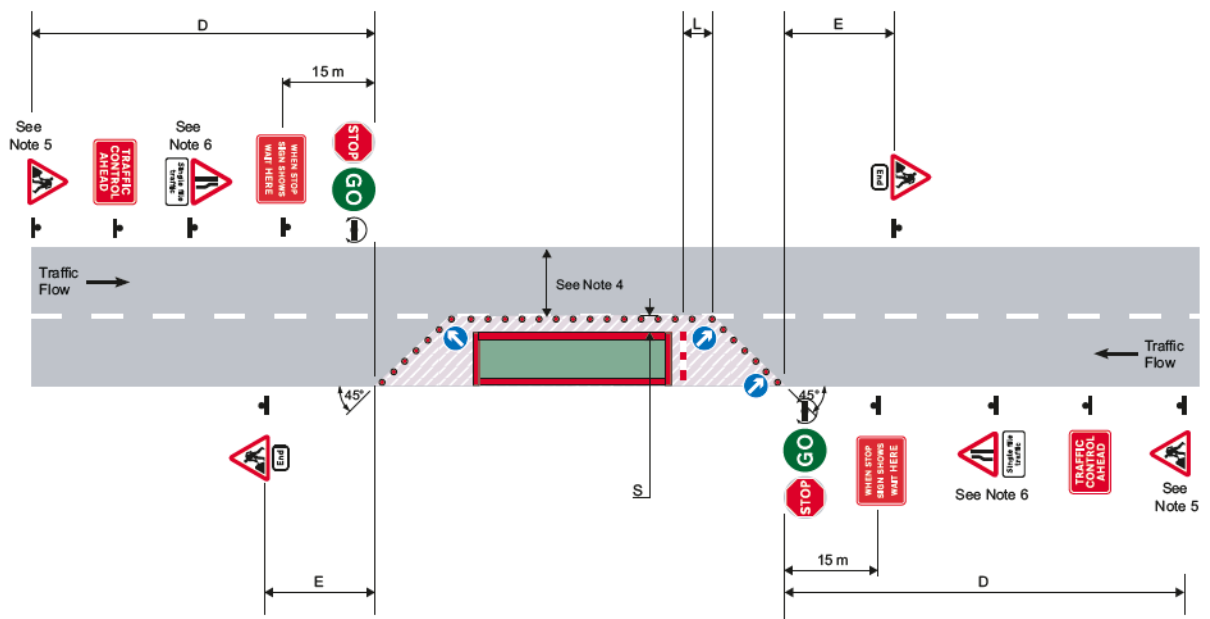

Plate 3.1 Indicative Temporary Traffic Management Arrangements (Stop/Go)

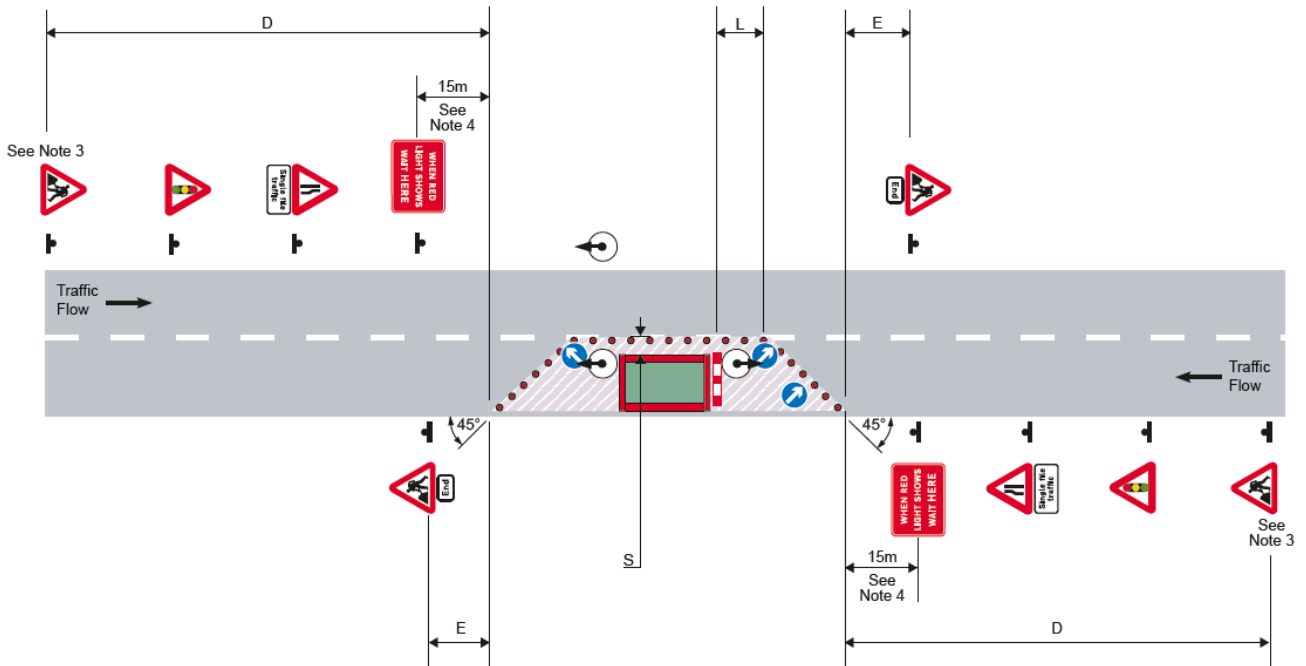

Plate 3.2 Indicative Temporary Traffic Management Arrangements (Traffic Signals)

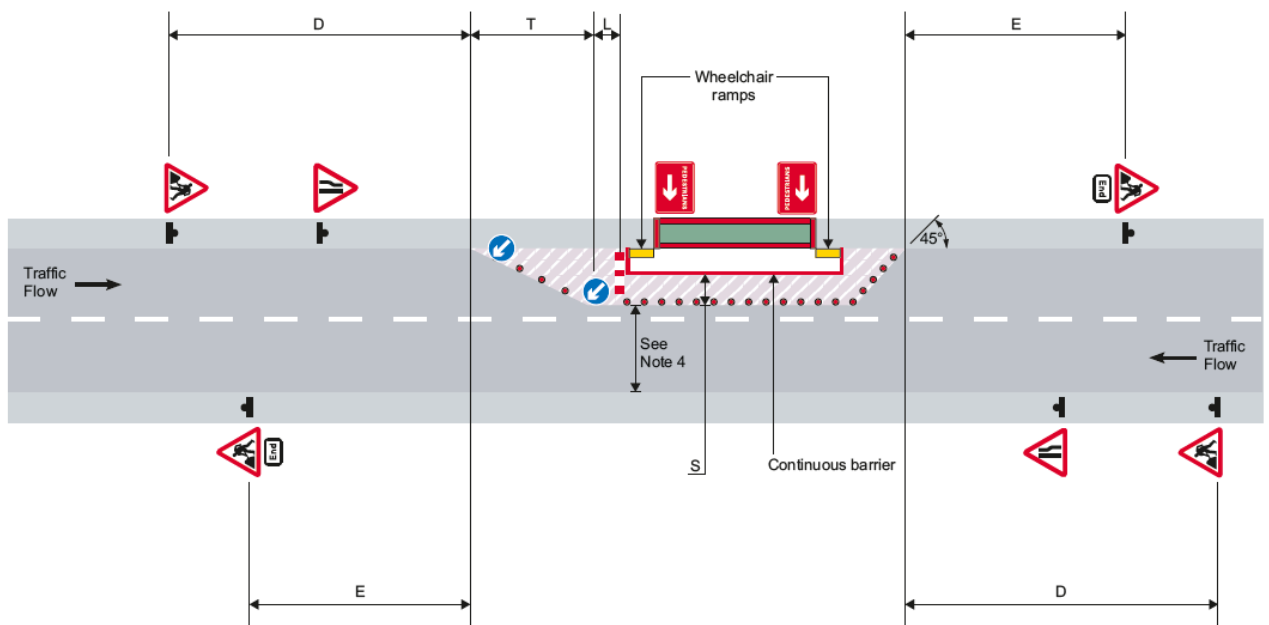

Plate 3.3 Indicative Temporary Traffic Management Arrangements (footway diversion into the carriageway)

56-57. Where the construction of the accesses and crossings would impact upon an existing footpath, the traffic management would incorporate a segregated area where pedestrians can safely walk through the works area. However, should the existing road width not safely permit such an arrangement then land within the



order limits will be utilised to ensure that a minimum highway lane of 3.0m, footway of 1.0 - 1.5m and a lateral safety clearance of 0.5m is maintained.

~~57.~~58. The detailed design of traffic management at accesses and crossings will be undertaken prior to construction and agreed with SCC and notified in accordance with the provisions within the Traffic Management Act 2004, the New Road and Street Works Act 1991 (and other relevant highways legislation where applicable) and draft DCO (Part 3).

~~58.~~59. For highway safety reasons, reductions in the posted speed limit to 30mph would be required for the duration of construction and reinstatement (where required) of all accesses and crossings. Additionally, **Table 2.3** provides a summary of the proposed speed limit changes for the duration of the proposed East Anglia TWO projects construction phase.

~~59.~~60. All temporary speed restrictions will be raised by SCC (at the Applicants cost) using their statutory powers.

3.2 Traffic Management – Sizewell Gap

~~60.~~61. The Applicant has developed an outline Sizewell Gap Construction Method Statement that details the works to be undertaken on Sizewell Gap and the associated mitigation measures to ensure emergency access to/from the Sizewell B Nuclear Power Station is maintained at all times.

~~61.~~62. The outline Sizewell Gap Construction Method Statement is included within the Code of Construction Practice and is secured by Requirement 22 of the draft DCO.

~~62.~~63. Pertinent to this OAMP is the impact of the construction of the access to works from Sizewell Gap. The construction and removal of accesses 1 and 2 would require the use of traffic management measures on Sizewell Gap.

~~63.~~64. These construction activities will be largely completed from within the order limits (i.e. off the public highway) and there would therefore be no requirement to close the highway at Sizewell Gap. However, there would be a requirement to undertake minimal tie-in works to the existing highway and shared use footway/cycleway which would require the temporary closure of one lane with traffic controlled through the use of temporary traffic signals.

~~64.~~65. Prior to commencement of the access works, the contractor will be required to engage with EDF Energy and the Suffolk Resilience Forum to provide relevant contact details. In the event that the contractor is made aware of an incident at the Sizewell Power station site (that requires unfettered access), the access



works would be suspended, the working area made safe and the traffic signals removed.

3.3 Onshore Preparation Works Traffic Controls

~~65-66.~~ An Onshore Preparation Works Management Plan (OPWMP) will be prepared.

~~66-67.~~ This section of the OAMP provides an outline of measures that would be implemented post-consent (within the OPWMP) to control traffic movements during the construction of the accesses and crossings, proportionate to the low level of demand likely to be generated during this activity.

3.3.1 Reporting

~~67-68.~~ Contact details for the Contractors representative will be submitted to SCC for their records prior to commencement of the onshore preparation works. Should the name or contact details change, revised details will be provided to SCC.

3.3.2 Timings

~~68-69.~~ In accordance with the OCoCP submitted as part of the DCO application, the standard construction working hours for the proposed East Anglia TWO project and any construction-related traffic movements will be between the following hours:

- 07:00 – 19:00 Monday to Friday; and
- 07:00 – 13:00 on Saturday.

~~69-70.~~ There may be times where construction would need to occur outside of the hours stated above; these would be agreed with the relevant planning authority prior to any such works being undertaken. In the event of an emergency, the relevant planning authority would be notified as soon as is practicable.

3.3.3 Delivery Routes

~~70-71.~~ Prior to the commencement of construction of the accesses and crossings, the Contractor will submit details to SCC and agree the routes to be used by traffic constructing the accesses and crossings.

~~71-72.~~ To ensure compliance with the agreed delivery routes, the following measures are proposed:

- Direction signing for the identified delivery routes would be implemented. This would direct construction traffic from the A12 to the respective accesses and crossings along the agreed delivery routes;



- Information signs will be erected in the vicinity of the accesses, which will include a telephone number for the public to report concerns;
- The delivery route instructions would be communicated by the Contractor to all companies and/or drivers involved in the transport of materials and plant in advance of access activities;
- The registration numbers for all HGVs making deliveries would be recorded by the Contractor. This would allow for checking and enforcement associated with any reported breaches of the agreed delivery routes; and
- The Contractor will provide all companies and/or drivers involved in the transport of materials and plant details of a unique identifier (e.g. the Contractor's logo) that that can be placed in the window of their vehicle. This will enable residents to identify if a HGV is engaged on work on the proposed East Anglia TWO project.

~~72-73.~~ 73-74. A method statement will be provided for the safe access and egress of Non-Special Order abnormal loads.

3.3.4 Control of Deposits on the Highway

~~73-74.~~ 73-74. To manage the potential for the deposition of detritus on the public highway, the Contractor will ensure:

- Regular inspections of the public highway in the vicinity of the accesses and crossing are undertaken to ensure it is free of detritus;
- A road sweeper is available on call to clear any detritus and other material from the public highway;
- A stiff brush / jet wash is available (at each access/ crossing) to allow drivers to clean vehicles prior to entering the public highway; and
- Any loaded vehicles entering and leaving are covered to prevent escape of materials during transport.

3.3.5 Enforcement and Corrective Measures

~~74-75.~~ 74-75. If the Contractor is made aware of a potential breach of the agreed delivery routes or operating hours (except where otherwise agreed with the relevant planning authority or in the event of an emergency), the Contractor will be required to investigate the circumstances and compile a report for the highway authority. The highway authority will then review the information, request further clarifications (if required) and confirm to the Contractor if a material breach has occurred.

~~75-76.~~ 75-76. If the breach is found to be material the following three stage process will be followed:



- Stage One – The highway authority confirms a breach and requests that the Contractor reviews the data and concerns. The highway authority and the Contractor would then agree the extent of the breach of controls and agree any action to be taken. This is likely to be a Contractor warning at this stage;
- Stage Two – If a further material breach is identified, the Contractor would be given a further warning and required to produce an action plan to outline how the issue would be rectified and any additional mitigation measures to be implemented; and
- Stage Three – Should further breaches occur the Contractor would be required to remove the relevant party from site and the Contractor / supplier would receive a formal warning. Any continued breaches by individuals of the Contractor / supplier may be dealt with by the formal dispute procedures of the contract.

~~76-77.~~ Individual employee breaches would be addressed through UK employment law whereby the three-stage process outlined above would form the basis for disciplinary proceedings.

3.4 Access 13 Operational Traffic Controls

~~77-78.~~ Access 13 would provide an operational access to the onshore substation and National Grid substation and would therefore remain for the operational life of the proposed East Anglia TWO project.

~~78-79.~~ The ES identifies that the proposed onshore substation and National Grid substation would not normally be staffed and that during the operational phase, vehicle movements would therefore be limited to occasional repair, maintenance and inspection visits at the substation.

~~79-80.~~ It is noted that the left turn from the A1094 to the B1121 is restricted due to the angle of the junction and that existing HGV movements via this junction must therefore pass to the opposite side of the road.

~~80-81.~~ In order not to exacerbate this existing situation the Applicant will ensure that all suppliers are issued with delivery instructions directing HGV drivers to approach from the south on the A1094 only (accessing from the B1069 via Leiston) following the SCC HGV lorry route network (**Annex 1**). This routing strategy would ensure that drivers can right turn from the A1094 to B1121, thereby avoiding the need to make the tight left turn.



4 References

Department for Transport (2013). Safety at street works and road works: a code of practice 2013

Department for Transport (2009). Traffic Signs Manual - Chapter 8 - Traffic Safety measures and Signs for Road Works and Temporary Situations, London: TSO

Department for Transport (2007). Manual for Streets, London: Thomas Telford Publishing

Highways England (August 2020). Design Manual for Roads and Bridges (DMRB) CD 123 - Geometric design of at-grade priority and signal controlled junctions

Highways England (January 2020). Design Manual for Roads and Bridges (DMRB) GG119 – Road Safety Audit



Annex 1: Suffolk – Lorry Route Network (extract)

Suffolk County Council, 2017. Lorry Route Map. Available online:
<https://www.suffolk.gov.uk/assets/Roads-and-transport/lorry-management/Lorry-Route-Map-Amended-MAY-17.pdf>



Annex 2: Proposed Preliminary Access Concepts

DRAWING No:
TP-PB4842-DR001

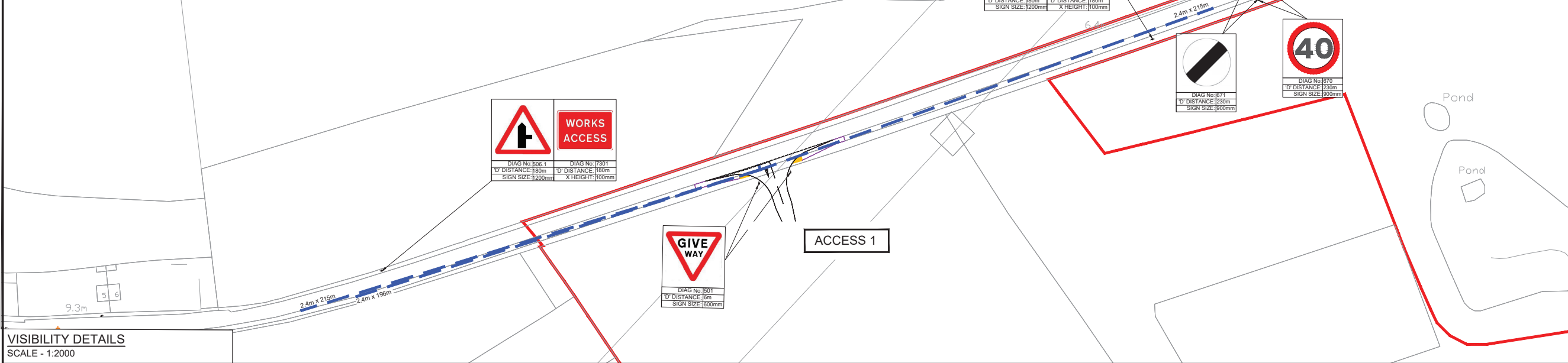

VISIBILITY DETAILS
SCALE - 1:2000

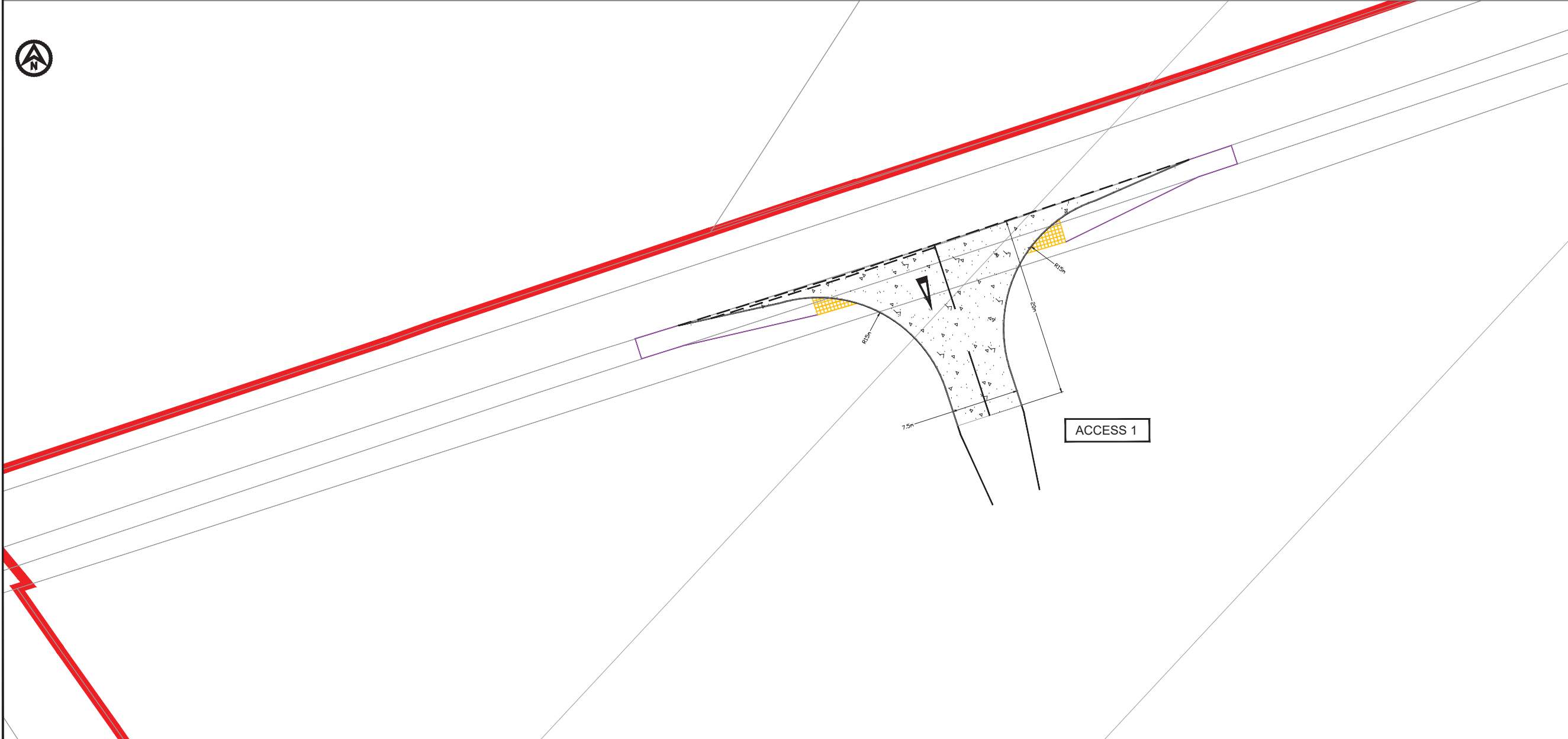

ACCESS DETAILS
SCALE - 1:500

- NOTES**
- Do not scale from this drawing, all dimensions are in metres unless noted otherwise.
 - This drawing has been based upon Ordnance Survey Maps and Royal HaskoningDHV can not guarantee the accuracy of data.
- Road markings and signs**
- All road markings and signage to conform with the Traffic Signs Regulation and General Directions 2016 and Chapter 8.
 - 'D' distance is the siting distance of temporary road signs from the closest haul road crossing point/access location.
- Visibility**
- X-distance - the set back from the nearest edge of the carriageway from which the access will be taken
 - Y-Distance - the SSD measured along the nearest edge of the carriageway to its intersection with the centreline of the access.
 - SSD - Stopping Sight Distance for design speed of the road.
 - All vegetation to be cleared/trimmed within identified visibility envelope.

KEY

- ORDER LIMITS
- PROPOSED EXTENDED CYCLEWAY
- PROPOSED ACCESS BOUNDARY/ROAD MARKINGS
- VISIBILITY SPLAY (SEE VISIBILITY TABLE)
- PROPOSED TEMPORARY ROAD SIGN
- FULL DEPTH CARRIAGEWAY CONSTRUCTION WITH BOUND SURFACE
- TACTILE PAVING

| ACCESS 1 - SIZEWELL GAP | VISIBILITY | |
|---|------------|------|
| | EAST | WEST |
| Posted Speed Limit (PSL) (mph) | 60 | 215 |
| Required Y-distance SSD for PSL (m) | 215 | 215 |
| Required Y-distance SSD achievable? | Yes | Yes |
| 85 th percentile speed (mph) | 57.1 | |

| REV | DATE | DESCRIPTION | BY | CHK | APP |
|------|----------|---------------------------------------|----|-----|-----|
| D0.6 | 24.07.19 | PAGE SIZE CHANGED FROM A3 TO A1 | JL | SKT | SKT |
| D0.5 | 07.06.19 | ORDER LIMITS, ACCESS LOCATION UPDATED | JL | SKT | SKT |
| D0.4 | 11.04.19 | ACCESS LOCATION AMENDED | JL | SKT | SKT |
| D0.3 | 11.04.19 | ACCESS LOCATION AMENDED | JL | SKT | SKT |
| D0.2 | 16.11.18 | ORDER LIMITS UPDATED | JL | SKT | ADR |
| D.01 | | FIRST ISSUE | | | |

REVISIONS

CLIENT



PROJECT

EAST ANGLIA TWO

TITLE

ACCESS 1
SIZEWELL GAP



| DRAWN | CHECKED | APPROVED |
|-------|---------|----------|
| JL | ST | ADR |

| DATE | SCALE AT A3 | AUTOCAD REF. |
|----------|-------------|--------------|
| 09.10.18 | VARIES | |

DRAWING No TP-PB4842-DR001

CLIENT DWG No. D0.6

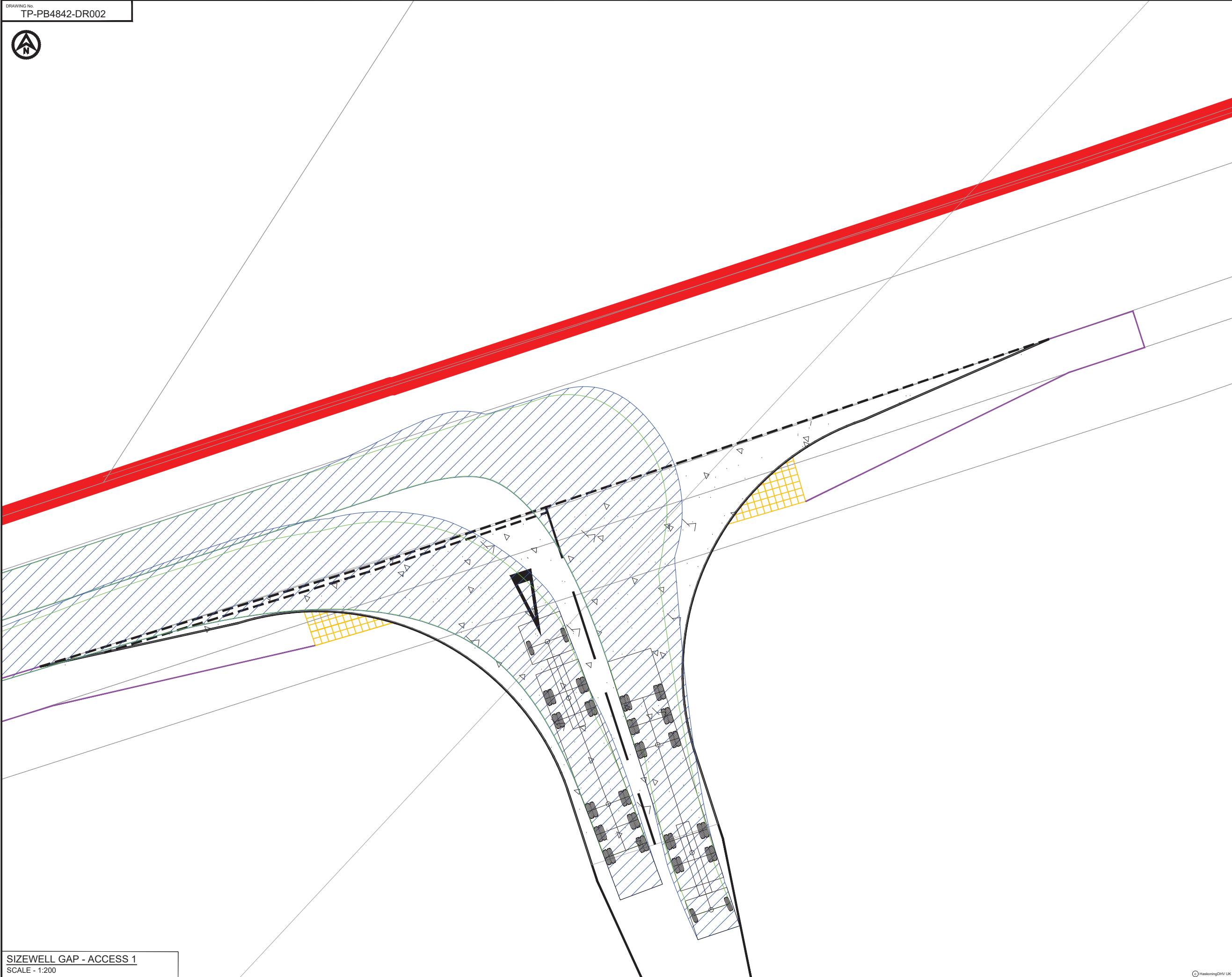

NOTES
 1. Do not scale from this drawing, all dimensions are in metres unless noted otherwise.
 2. This drawing has been based upon Ordnance Survey Maps and Royal HaskoningDHV can not guarantee the accuracy of data.

- KEY**
- ORDER LIMITS
 - PROPOSED EXTENDED CYCLEWAY
 - - - PROPOSED ACCESS BOUNDARY/ROAD MARKINGS

FULL DEPTH CARRIAGEWAY CONSTRUCTION WITH BOUND SURFACE

TACTILE PAVING

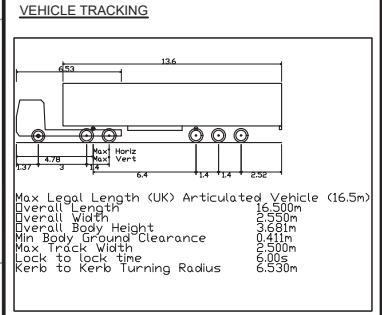

- VEHICLE BODY SWEEP PATH (FORWARD GEAR)
- VEHICLE CHASSIS SWEEP PATH

| | | | | | |
|------|----------|---------------------------------------|----|-----|-----|
| DD.3 | 24.07.19 | DRAWING TITLE AMENDED | JL | SKT | SKT |
| DD.2 | 10.06.19 | ORDER LIMITS, ACCESS LOCATION UPDATED | JL | SKT | SKT |
| D.01 | | FIRST ISSUE | | | |
| REV | DATE | DESCRIPTION | BY | CHK | APP |

REVISIONS

CLIENT

PROJECT

EAST ANGLIA TWO

TITLE

ACCESS 1
 SIZEWELL GAP
 MAX ARTICULATED HGV
 SWEEP PATH ANALYSIS
 (RIGHT TURN IN / LEFT TURN OUT)

Enterprise House,
 Delta Way, Segrham,
 Surrey, TW20 8PX
 Tel +44(0)1932 969568
 www.royalhaskoningdhv.com

| | | | | | |
|----------------|-----------------|-------------|-------|--------------|------|
| DRAWN | JL | CHECKED | SKT | APPROVED | ADR |
| DATE | 09.10.18 | SCALE AT A3 | 1:200 | AUTOCAD REF. | |
| DRAWING No. | TP-PB4842-DR002 | | | REVISION | D0.3 |
| CLIENT DWG No. | | | | | |

SIZEWELL GAP - ACCESS 1
 SCALE - 1:200

DRAWING No.
TP-PB4842-DR003

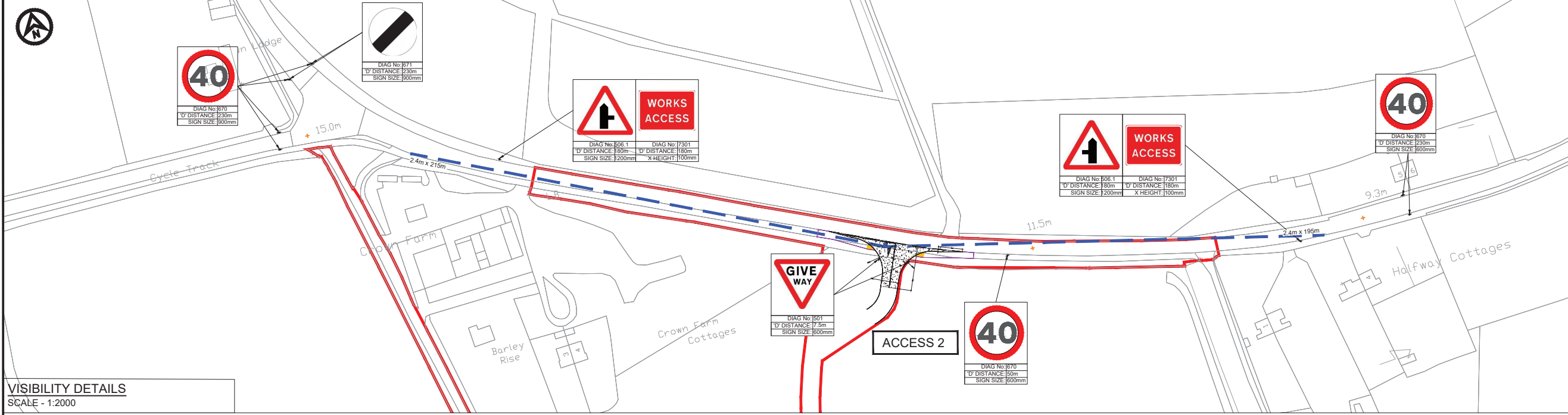

VISIBILITY DETAILS
SCALE - 1:2000

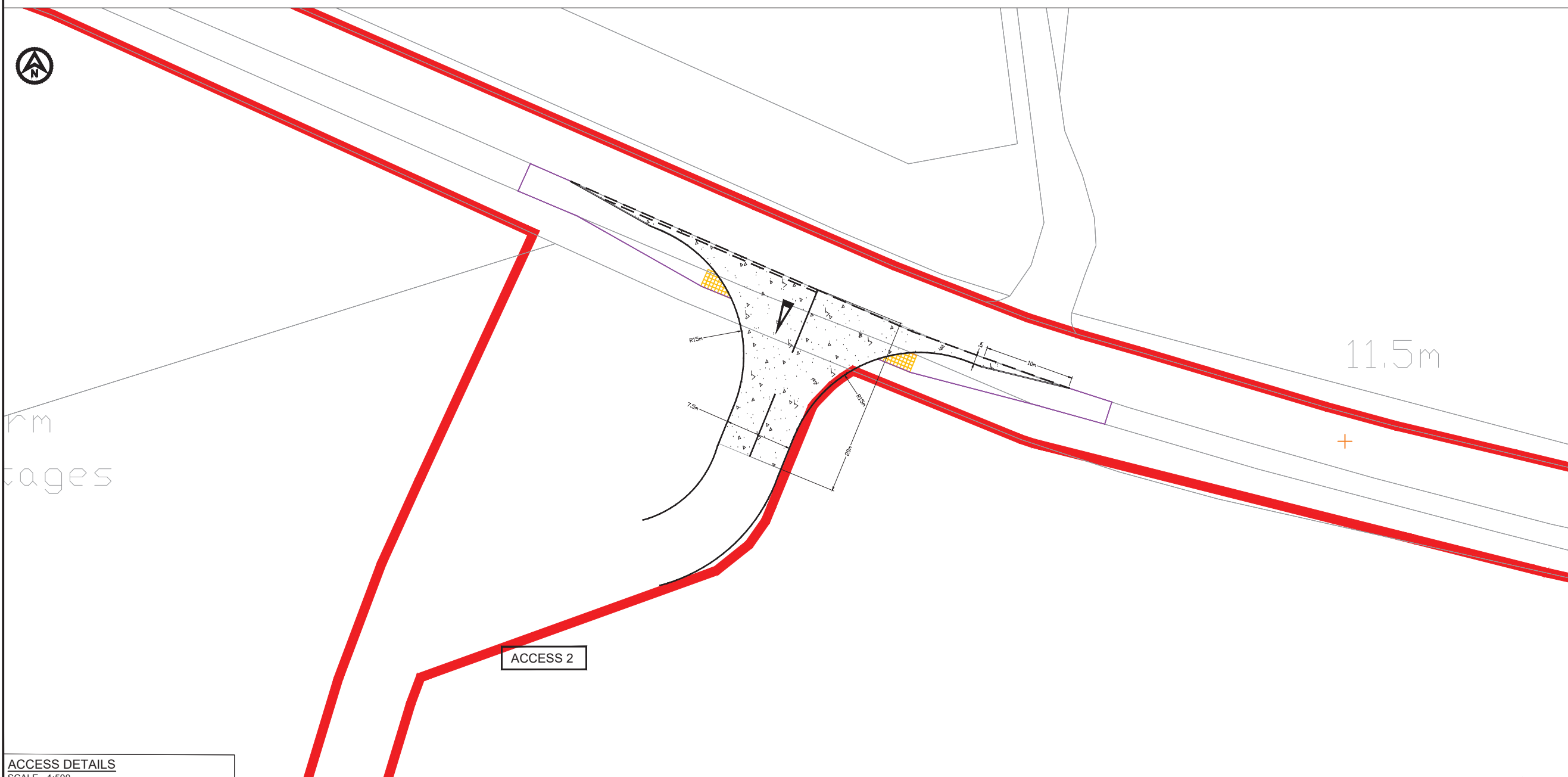

ACCESS DETAILS
SCALE - 1:500

- NOTES**
- Do not scale from this drawing, all dimensions are in metres unless noted otherwise.
 - This drawing has been based upon Ordnance Survey Maps and Royal HaskoningDHV can not guarantee the accuracy of data.
- Road markings and signs**
- All road markings and signage to conform with the 'Traffic Signs Regulation and General Directions 2016 and Chapter 8.
 - 'D' distance is the siting distance of temporary road signs from the closest haul road crossing point/access location.
- Visibility**
- X-distance - the set back from the nearest edge of the carriageway from which the access will be taken
 - Y-Distance - the SSD measured along the nearest edge of the carriageway to its intersection with the centreline of the access.
 - SSD - Stopping Sight Distance for design speed of the road.
 - All vegetation to be cleared/trimmed within identified visibility envelope.

KEY

- ORDER LIMITS
- PROPOSED EXTENDED CYCLEWAY
- PROPOSED ACCESS BOUNDARY/ROAD MARKINGS
- VISIBILITY SPLAY (SEE VISIBILITY TABLE)
- PROPOSED TEMPORARY ROAD SIGN
- FULL DEPTH CARRIAGEWAY CONSTRUCTION WITH BOUND SURFACE
- TACTILE PAVING

| | VISIBILITY | |
|---|------------|------|
| | EAST | WEST |
| Posted Speed Limit (PSL) (mph) | | 60 |
| Required Y-distance SSD for PSL (m) | | 215 |
| Existing achievable Y-distance SSD (m) | 195 | 215 |
| Required Y-distance SSD achievable? | No | Yes |
| 85 th percentile speed (mph) | | 57.1 |
| Required Y-distance SSD for 85 th percentile speed (m) | | 215 |
| Existing Y-distance SSD suitable for 85 th percentile speeds | No | Yes |
| Proposed Reduced Speed Limit (RSL) (mph) | | 40 |
| Assumed design speed (mph) | | 40 |
| Required Y-distance SSD for design speed (m) | | 120 |
| Required Y-distance SSD achievable? | Yes | Yes |
| Traffic control measures required | | Yes |

Distances measured on site.

| REV | DATE | DESCRIPTION | BY | CHK | APP |
|------|----------|---------------------------------|----|-----|-----|
| D0.4 | 24.07.19 | PAGE SIZE CHANGED FROM A3 TO A1 | J | SKT | SKT |
| D0.3 | 10.06.19 | ORDER LIMITS UPDATED | J | SKT | SKT |
| D0.2 | 16.11.18 | ORDER LIMITS UPDATED | J | SKT | ADR |
| D.01 | | FIRST ISSUE | | | |

REVISIONS

CLIENT



PROJECT

EAST ANGLIA TWO

TITLE

ACCESS 2
SIZEWELL GAP

DRAWN



CHECKED

DATE 09.10.18 SCALE AT A3 VARIES AUTOCAD REF.

DRAWING No. TP-PB4842-DR003 REVISION D0.4

CLIENT DWG No.

DRAWING No. TP-PB4842-DR004

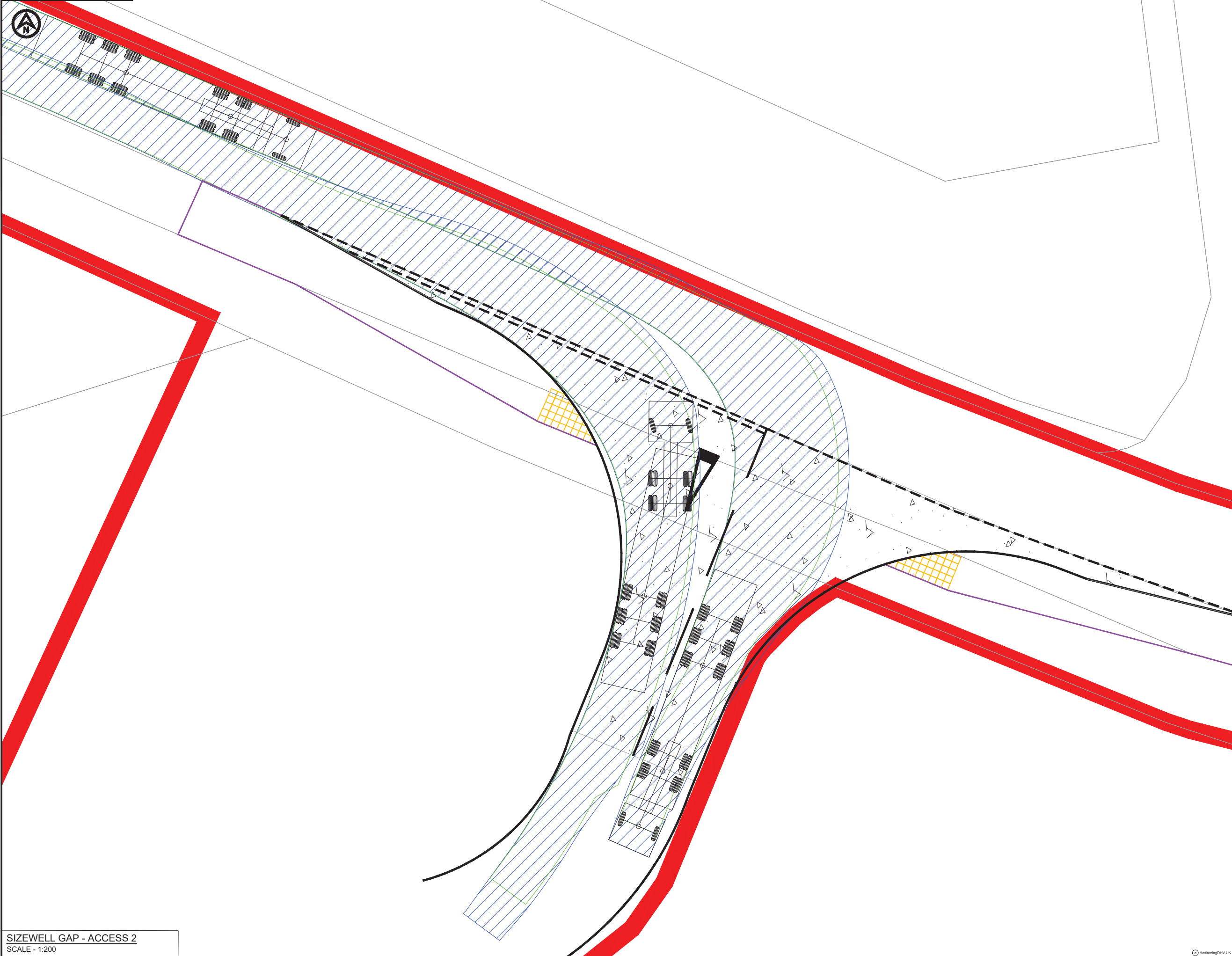

NOTES
 1. Do not scale from this drawing, all dimensions are in metres unless noted otherwise.
 2. This drawing has been based upon Ordnance Survey Maps and Royal HaskoningDHV can not guarantee the accuracy of data.

KEY
 ORDER LIMITS
 PROPOSED EXTENDED CYCLEWAY
 PROPOSED ACCESS BOUNDARY/ROAD MARKINGS

FULL DEPTH CARRIAGEWAY CONSTRUCTION WITH BOUND SURFACE
 TACTILE PAVING

VEHICLE TRACKING

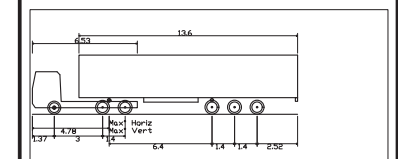

Max Legal Length (UK) Articulated Vehicle (16.5m)
 Overall Length 16.500m
 Overall Width 2.550m
 Overall Body Height 3.281m
 Min Body Ground Clearance 0.411m
 Max Track Width 2.550m
 Lock to lock time 6.00s
 Kerb to Kerb Turning Radius 6.530m

VEHICLE BODY SWEEP PATH (FORWARD GEAR)
 VEHICLE CHASSIS SWEEP PATH

| REV | DATE | DESCRIPTION | BY | CHK | APP |
|------|----------|-----------------------|----|-----|-----|
| D0.3 | 24.07.19 | DRAWING TITLE AMENDED | JL | SKT | SKT |
| D0.2 | 10.06.19 | ORDER LIMITS, UPDATED | JL | SKT | SKT |
| D.01 | | FIRST ISSUE | | | |

REVISIONS

CLIENT



PROJECT

EAST ANGLIA TWO

TITLE

ACCESS 2
 SIZEWELL GAP
 MAX ARTICULATED HGV
 SWEEP PATH ANALYSIS
 (RIGHT TURN IN / LEFT TURN OUT)



| DRAWN | JL | CHECKED | SKT | APPROVED | ADR |
|-------|----------|-------------|-------|--------------|-----|
| DATE | 09.10.18 | SCALE AT A3 | 1:200 | AUTOCAD REF. | |

| DRAWING No. | TP-PB4842-DR004 | REVISION |
|----------------|-----------------|----------|
| CLIENT DWG No. | | D0.3 |

SIZEWELL GAP - ACCESS 2
 SCALE - 1:200

DRAWING No.
TP-PB4842-DR007

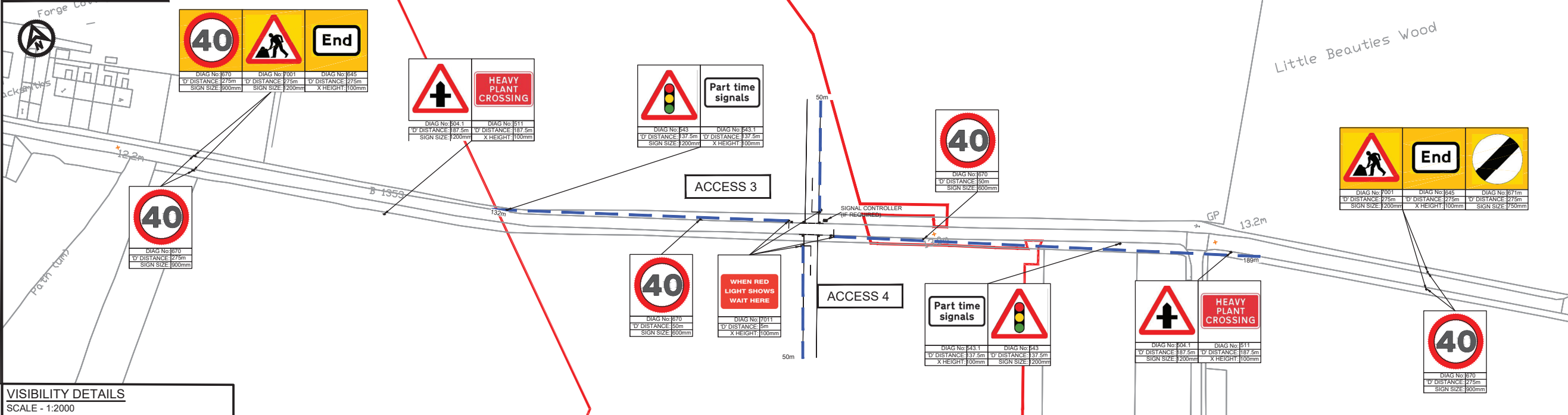

VISIBILITY DETAILS
SCALE - 1:2000

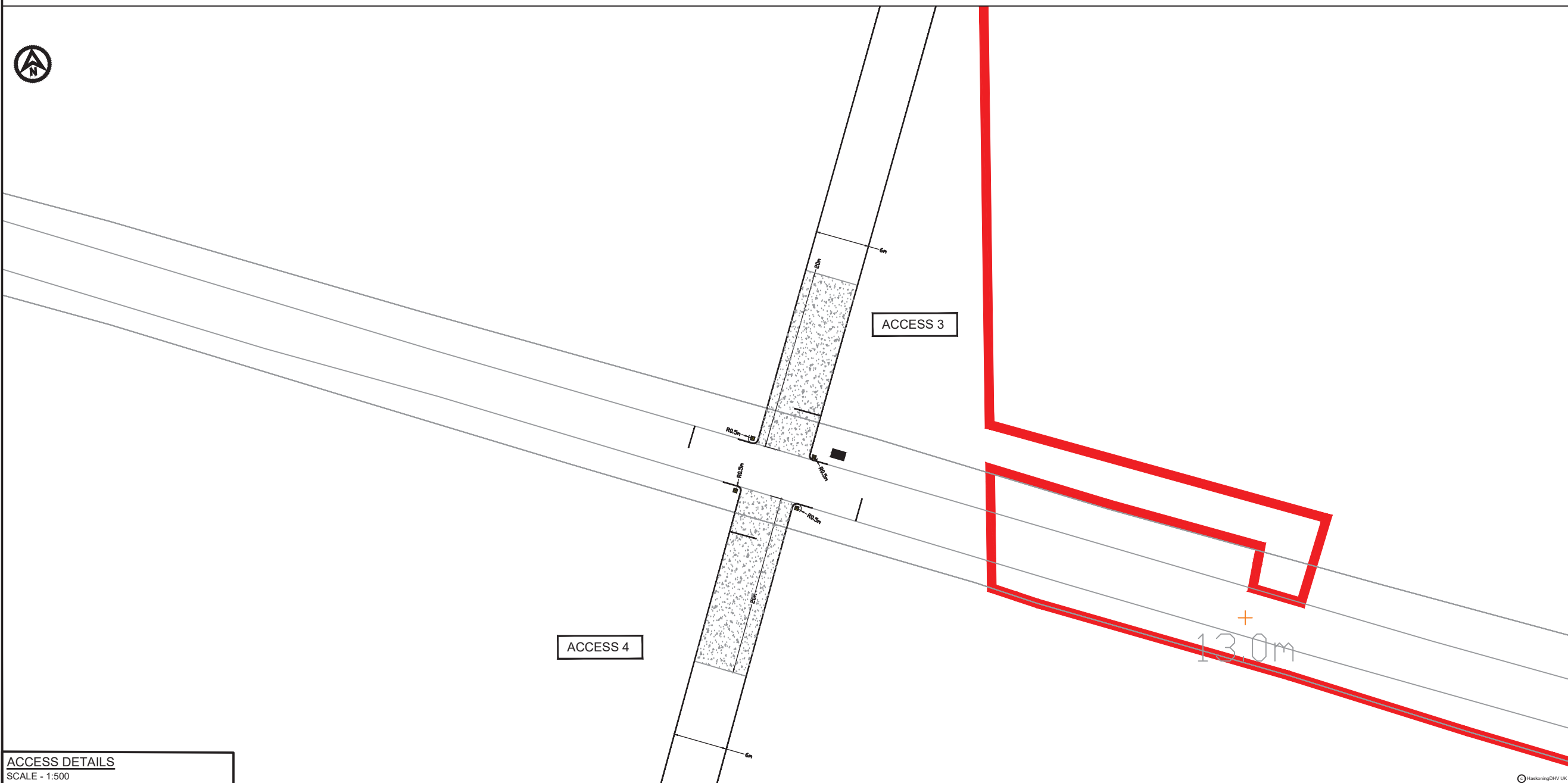

ACCESS DETAILS
SCALE - 1:500

NOTES
 1. Do not scale from this drawing, all dimensions are in metres unless noted otherwise.
 2. This drawing has been based upon Ordnance Survey Maps and Royal HaskoningDHV can not guarantee the accuracy of data.
 3. All road markings and signage to conform with the Traffic Signs Regulation and General Directions 2016 and Chapter 8.
 4. 'D' distance is the siting distance of temporary road signs from the closest haul road crossing point/access location.
 5. SSD - Stopping Sight Distance to traffic signals for design speed of road.
 6. All vegetation to be cleared/trimmed within identified visibility envelope.

- KEY**
- FULL DEPTH CARRIAGEWAY CONSTRUCTION WITH BOUND SURFACE
 - ORDER LIMITS
 - PROPOSED ACCESS BOUNDARY/ROAD MARKINGS
 - SSD TO TRAFFIC LIGHTS (SEE VISIBILITY TABLE)
 - PROPOSED TEMPORARY ROAD SIGN
 - PROPOSED TRAFFIC SIGNAL
 - TRAFFIC SIGNAL INTERVISIBILITY ZONE
 - PROPOSED YELLOW DEMARCATION BOLLARD

| ACCESS 3 - NORTH SIDE OF B1353 (EAST OF ALDRINHAM) | | VISIBILITY | |
|--|--|------------|------|
| | | EAST | WEST |
| Proposed Speed Limit (PSL) (mph) | | | 215 |
| Required SSD for PSL (m) | | | 60 |
| Existing achievable SSD (m) | | N/A | 132 |
| Required SSD achievable? | | | No |
| 85 th percentile speed (mph) | | | 54.1 |
| Required SSD for 85 th percentile speed (m) | | | 215 |
| Existing SSD suitable for 85 th percentile speeds | | N/A | No |
| Proposed Reduced Speed Limit (RSL) (mph) | | | 40 |
| Assumed design speed (mph) | | | 40 |
| Required SSD for design speed (m) | | | 120 |
| Required SSD achievable? | | N/A | Yes |
| Traffic control measures required | | | Yes |

| ACCESS 4 - SOUTH SIDE OF B1353 (EAST OF ALDRINHAM) | | VISIBILITY | |
|--|--|------------|------|
| | | EAST | WEST |
| Proposed Speed Limit (PSL) (mph) | | | 50 |
| Required SSD for PSL (m) | | | 215 |
| Existing achievable SSD (m) | | 189 | N/A |
| Required SSD achievable? | | No | N/A |
| 85 th percentile speed (mph) | | | 54.1 |
| Required SSD for 85 th percentile speed (m) | | | 215 |
| Existing SSD suitable for 85 th percentile speeds | | No | N/A |
| Proposed Reduced Speed Limit (RSL) (mph) | | | 40 |
| Assumed design speed (mph) | | | 40 |
| Required SSD for design speed (m) | | | 120 |
| Required SSD achievable? | | Yes | N/A |
| Traffic control measures required | | | Yes |

| ACCESS 4 & 5 FROM HAUL ROAD | | VISIBILITY | |
|---------------------------------------|--|------------|------|
| | | EAST | WEST |
| Proposed Site Speed Limit (PSL) (mph) | | | 20 |
| Required SSD for PSL (m) | | | 50 |

| | | | | | |
|------|----------|---------------------------------------|----|-----|-----|
| D0.0 | 15.03.21 | VISIBILITY SPLAYS UPDATED | JL | SKT | SKT |
| D0.5 | 24.07.19 | PAGE SIZE CHANGED FROM A3 TO A1 | JL | SKT | SKT |
| D0.4 | 10.06.19 | ORDER LIMITS, ACCESS LOCATION UPDATED | JL | SKT | SKT |
| D.03 | 16.11.18 | ORDER LIMIT UPDATED | JL | SKT | ADR |
| D.02 | 14.11.18 | EXTENSION OF TEMPORARY SPEED LIMIT | JL | SKT | ADR |
| D.01 | | FIRST ISSUE | | | |

REVISIONS

CLIENT



PROJECT

EAST ANGLIA TWO

TITLE

ACCESS 3 & 4
B1353



DRAWN JL CHECKED ST APPROVED ADR

DATE 09.10.18 SCALE AT A3 VARIES AUTOCAD REF.

DRAWING No TP-PB4842-DR007 REVISION

CLIENT DWG No. D0.6

DRAWING No:
TP-PB4842-DR008

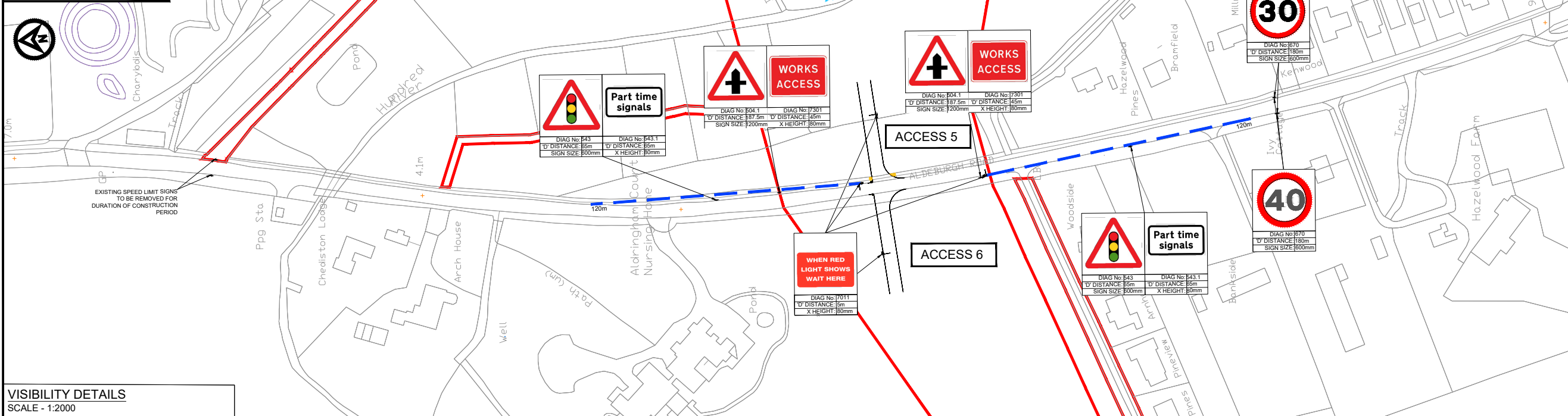

VISIBILITY DETAILS
SCALE - 1:2000

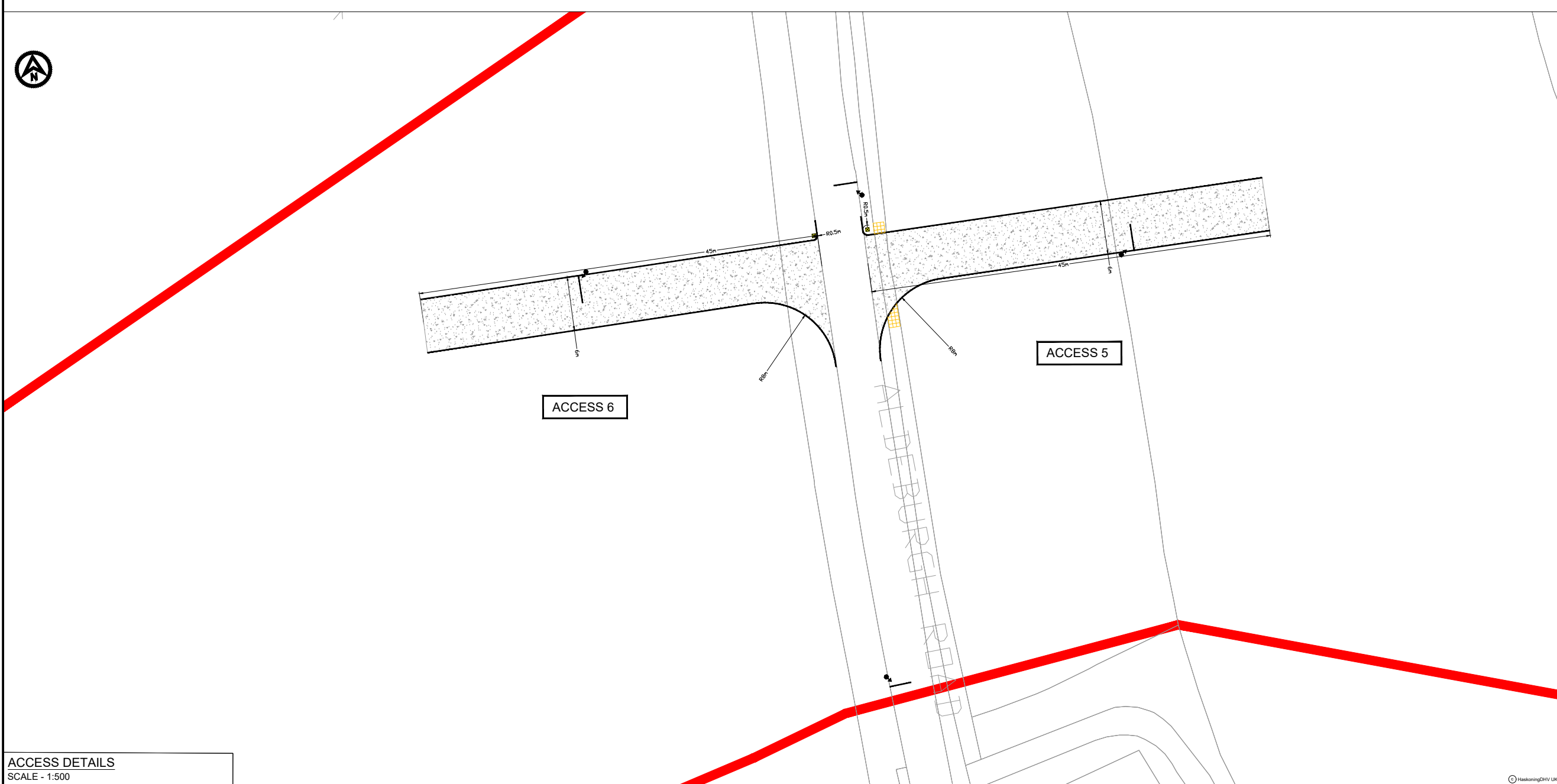

ACCESS DETAILS
SCALE - 1:500

- NOTES**
- Do not scale from this drawing, all dimensions are in metres unless noted otherwise.
 - This drawing has been based upon Ordnance Survey Maps and Royal HaskoningDHV can not guarantee the accuracy of data.
- Road markings and signs**
- All road markings and signage to conform with the 'Traffic Signs Regulation and General Directions 2016 and Chapter 8.
 - 'D' distance is the siting distance of temporary road signs from the closest haul road crossing point/access location.
- Visibility**
- SSD - Stopping Sight Distance for design speed of the road.
 - All vegetation to be cleared/trimmed within identified visibility envelope.

- KEY**
- ORDER LIMITS
 - PROPOSED ACCESS BOUNDARY/ROAD MARKINGS
 - VISIBILITY SPLAY (SEE VISIBILITY TABLE)
 - PROPOSED TEMPORARY ROAD SIGN
 - PROPOSED TEMPORARY TRAFFIC SIGNAL
 - PROPOSED BOLLARD
 - FULL DEPTH CARRIAGEWAY CONSTRUCTION WITH BOUND SURFACE
 - TACTILE PAVING

ACCESS 5 - EAST SIDE OF B1122 (SOUTH OF ALDRINGHAM)

| | NORTH | SOUTH |
|---|-------|-------|
| Posted Speed Limit (PSL) (mph) | 40 | 40 |
| Required Y-distance SSD for PSL (m) | 120 | 120 |
| Existing achievable Y-distance SSD (m) | 120 | 120 |
| Required Y-distance SSD achievable? | Yes | Yes |
| 85 th percentile speed (mph) | 44.7 | 44.7 |
| Required Y-distance SSD for 85 th percentile speed (m) | 120 | 120 |
| Existing Y-distance SSD suitable for 85 th percentile speeds | Yes | Yes |
| Proposed Reduced Speed Limit (RSL) (mph) | 30 | 30 |
| Assumed design speed (mph) | 30 | 30 |
| Required Y-distance SSD for design speed (m) | 90 | 90 |
| Required Y-distance SSD achievable? | Yes | Yes |

ACCESS 6 - WEST SIDE OF B1122 (SOUTH OF ALDRINGHAM)

| | NORTH | SOUTH |
|---|-------|-------|
| Posted Speed Limit (PSL) (mph) | 40 | 40 |
| Required Y-distance SSD for PSL (m) | 120 | 120 |
| Existing achievable Y-distance SSD (m) | 120 | 120 |
| Required Y-distance SSD achievable? | Yes | Yes |
| 85 th percentile speed (mph) | 44.7 | 44.7 |
| Required Y-distance SSD for 85 th percentile speed (m) | 120 | 120 |
| Existing Y-distance SSD suitable for 85 th percentile speeds | Yes | Yes |
| Proposed Reduced Speed Limit (RSL) (mph) | 30 | 30 |
| Assumed design speed (mph) | 30 | 30 |
| Required Y-distance SSD for design speed (m) | 90 | 90 |
| Required Y-distance SSD achievable? | Yes | Yes |

| REV | DATE | DESCRIPTION | BY | CHK | APP |
|-------|----------|---------------------------------------|----|-----|-----|
| D0.7 | 17.03.21 | ACCESS STRATEGY REVISED | JL | SKT | SKT |
| D0.6 | 26.11.20 | SPEED LIMIT CHANGED | JL | SKT | SKT |
| D0.5 | 24.07.19 | PAGE SIZE CHANGED FROM A3 TO A1 | JL | SKT | SKT |
| D0.4 | 11.06.19 | ORDER LIMITS, ACCESS LOCATION UPDATED | JL | SKT | SKT |
| D0.3 | 11.04.19 | HIGHWAY BOUNDARY ADDED | JL | SKT | SKT |
| D0.2 | 16.11.18 | ORDER LIMITS UPDATED | JL | SKT | ADR |
| D.0.1 | | FIRST ISSUE | | | |



PROJECT

EAST ANGLIA TWO

TITLE

SIGNAL CONTROLLED ACCESS 5 & 6
B1122 ALDEBURGH ROAD



| DRAWN | CHECKED | APPROVED |
|----------------|-----------------|--------------|
| JL | ST | ADR |
| DATE | SCALE AT A3 | AUTOCAD REF. |
| 09.10.18 | VARIIES | |
| DRAWING No. | TP-PB4842-DR008 | REVISION |
| CLIENT DWG No. | | D0.7 |

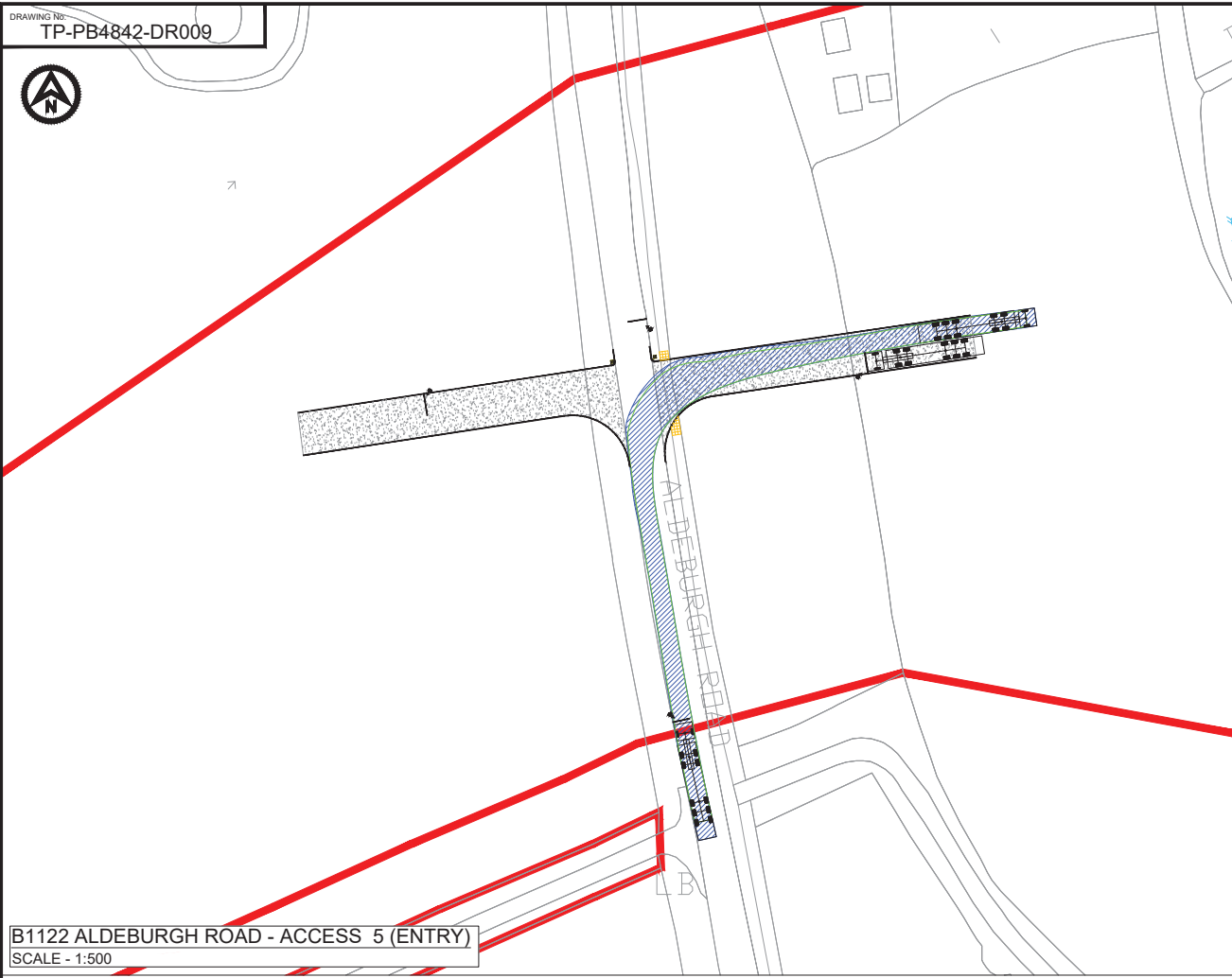

B1122 ALDEBURGH ROAD - ACCESS 5 (ENTRY)
SCALE - 1:500

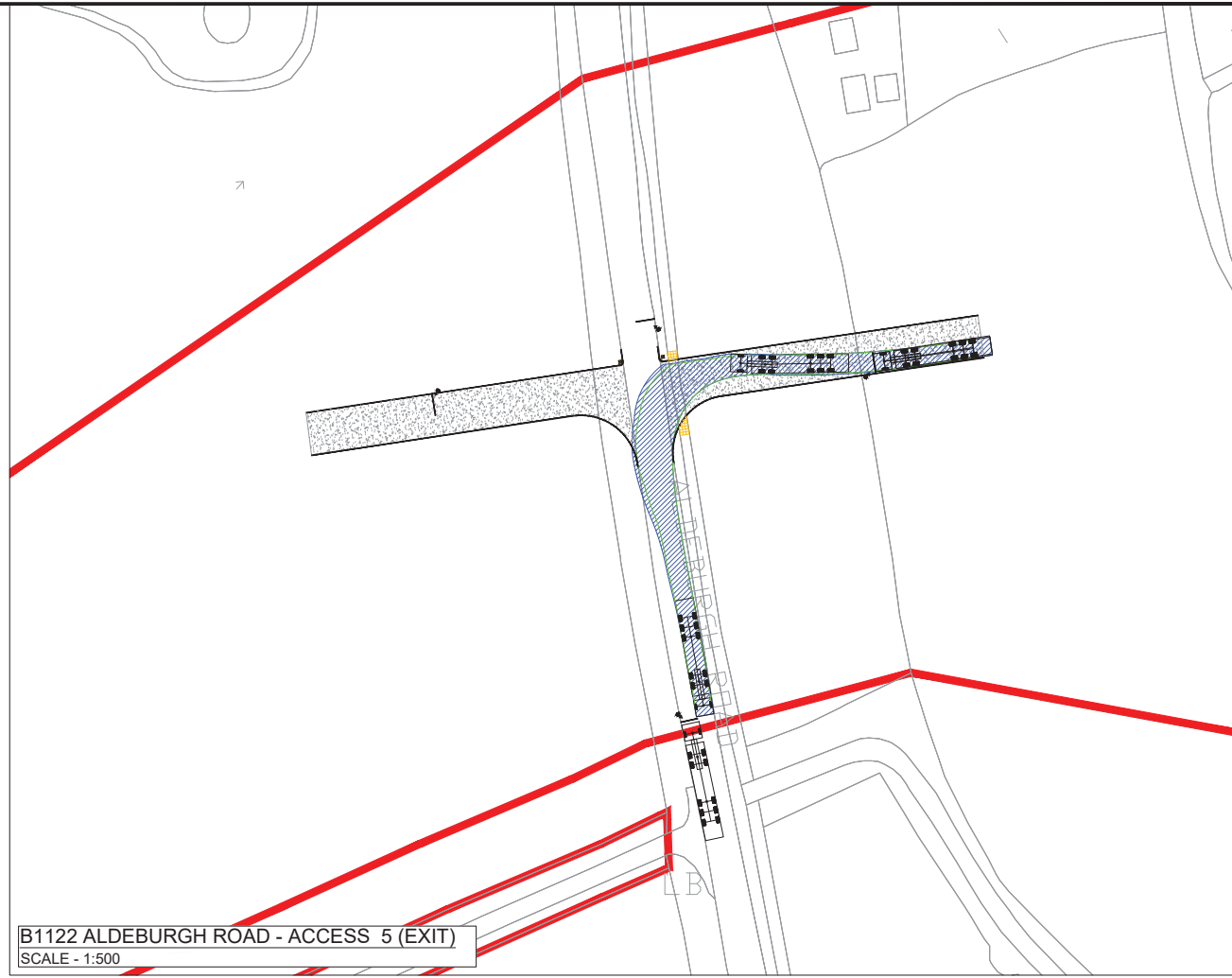

B1122 ALDEBURGH ROAD - ACCESS 5 (EXIT)
SCALE - 1:500

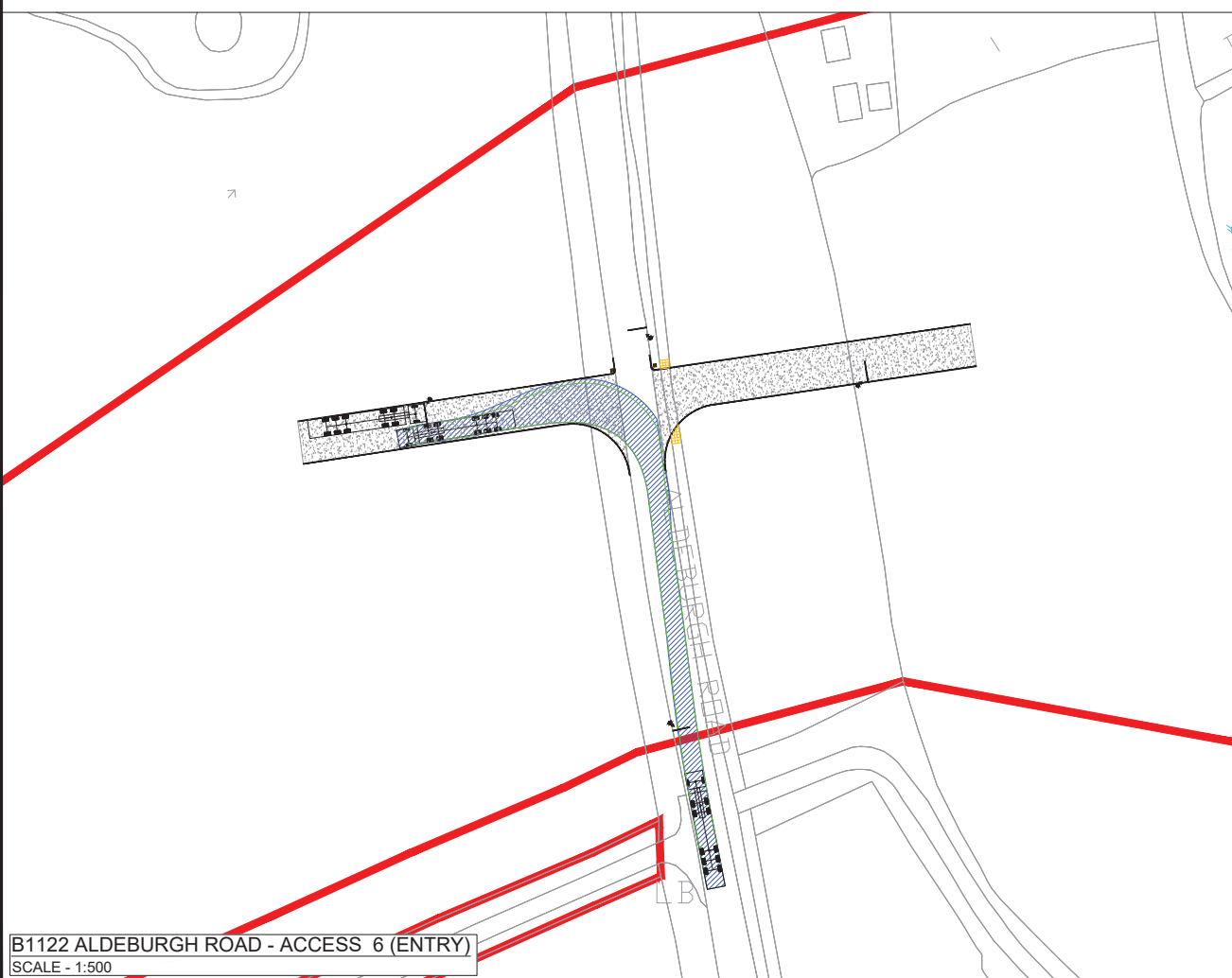

B1122 ALDEBURGH ROAD - ACCESS 6 (ENTRY)
SCALE - 1:500

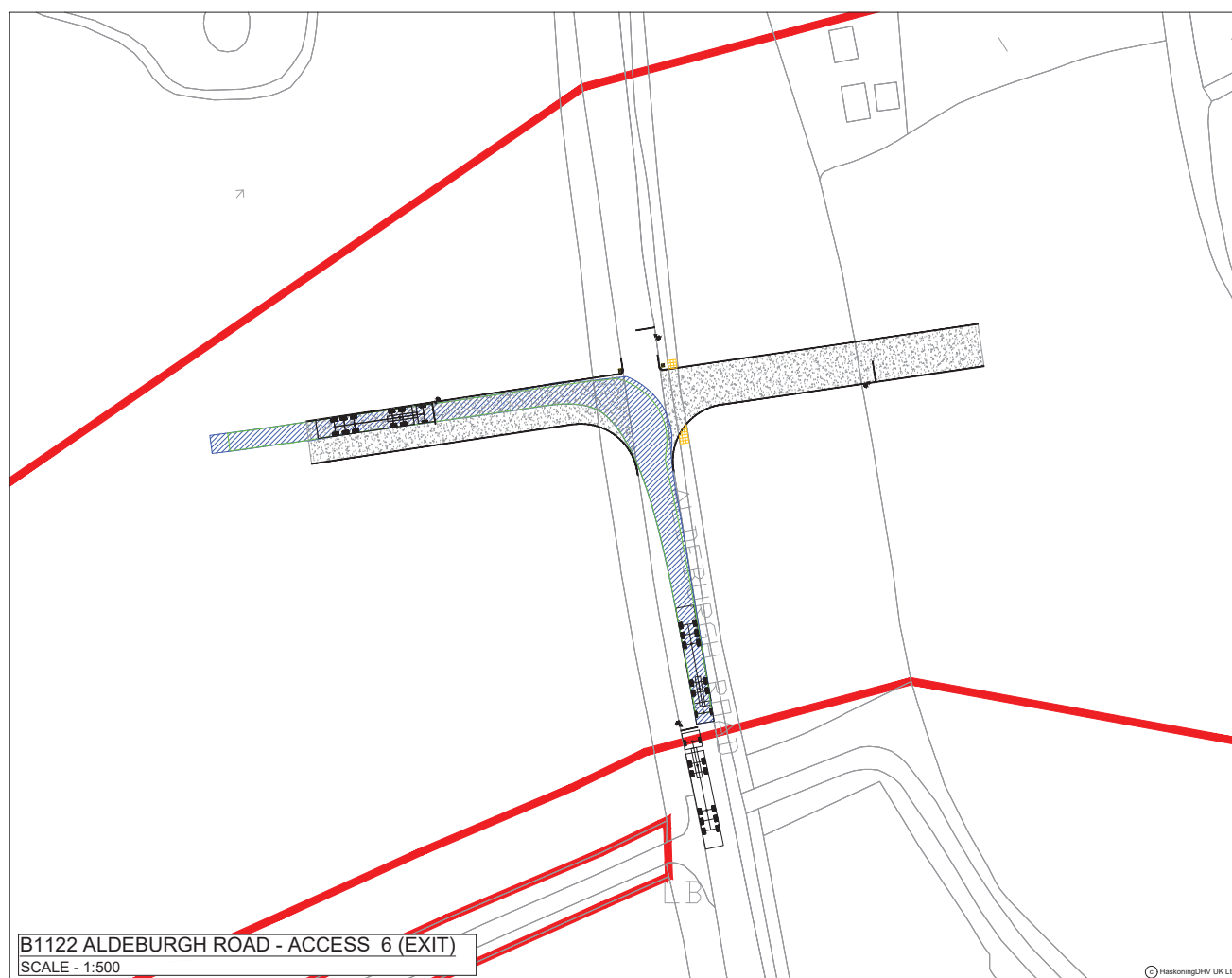

B1122 ALDEBURGH ROAD - ACCESS 6 (EXIT)
SCALE - 1:500

- NOTES**
- Do not scale from this drawing, all dimensions are in metres unless noted otherwise.
 - This drawing has been based upon Ordnance Survey Maps and Royal HaskoningDHV can not guarantee the accuracy of data.

- KEY**
- ORDER LIMITS
 - PROPOSED ACCESS BOUNDARY/ROAD MARKINGS
 - PROPOSED TEMPORARY TRAFFIC SIGNAL
 - PROPOSED BOLLARD

- FULL DEPTH CARRIAGEWAY CONSTRUCTION WITH BOUND SURFACE
- TACTILE PAVING

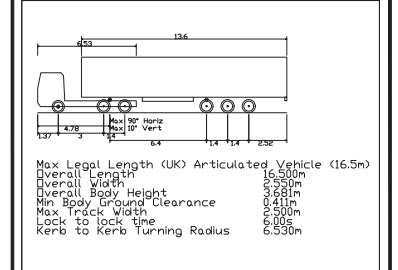

- VEHICLE BODY SWEEP PATH (FORWARD GEAR)
- VEHICLE CHASSIS SWEEP PATH

| | | | | | |
|------|----------|---------------------------------------|----|-----|-----|
| D0.4 | 17.03.21 | ACCESS STRATEGY REVISED | JL | SKT | SKT |
| D0.3 | 24.07.18 | DRAWING TITLE AMENDED | JL | SKT | SKT |
| D0.2 | 11.06.18 | ORDER LIMITS, ACCESS LOCATION UPDATED | JL | SKT | SKT |
| D.01 | | FIRST ISSUE | | | |
| REV | DATE | DESCRIPTION | BY | CHK | APP |

REVISIONS



PROJECT EAST ANGLIA TWO

TITLE
SIGNAL CONTROLLED ACCESS 5 & 6
B1122 ALDEBURGH ROAD
MAX ARTICULATED HGV
SWEEP PATH ANALYSIS



| | | | | | |
|----------------|-----------------|-------------|----------|--------------|------|
| DRAWN | JL | CHECKED | SKT | APPROVED | ADR |
| DATE | 09.10.18 | SCALE AT A1 | AS SHOWN | AUTOCAD REF. | |
| DRAWING No. | TP-PB4842-DR009 | | | REVISION | |
| CLIENT DWG No. | | | | | D0.4 |

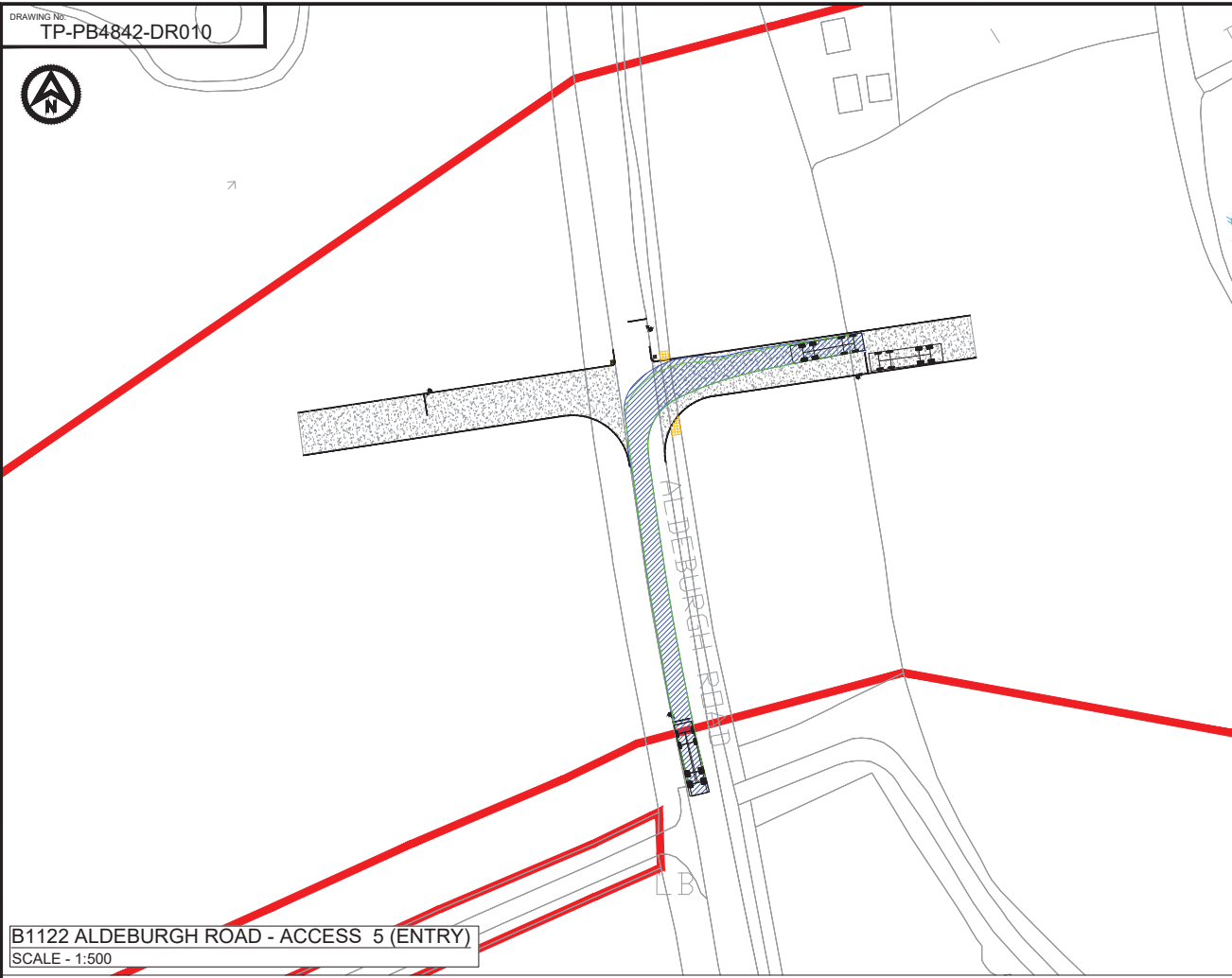

B1122 ALDEBURGH ROAD - ACCESS 5 (ENTRY)
SCALE - 1:500

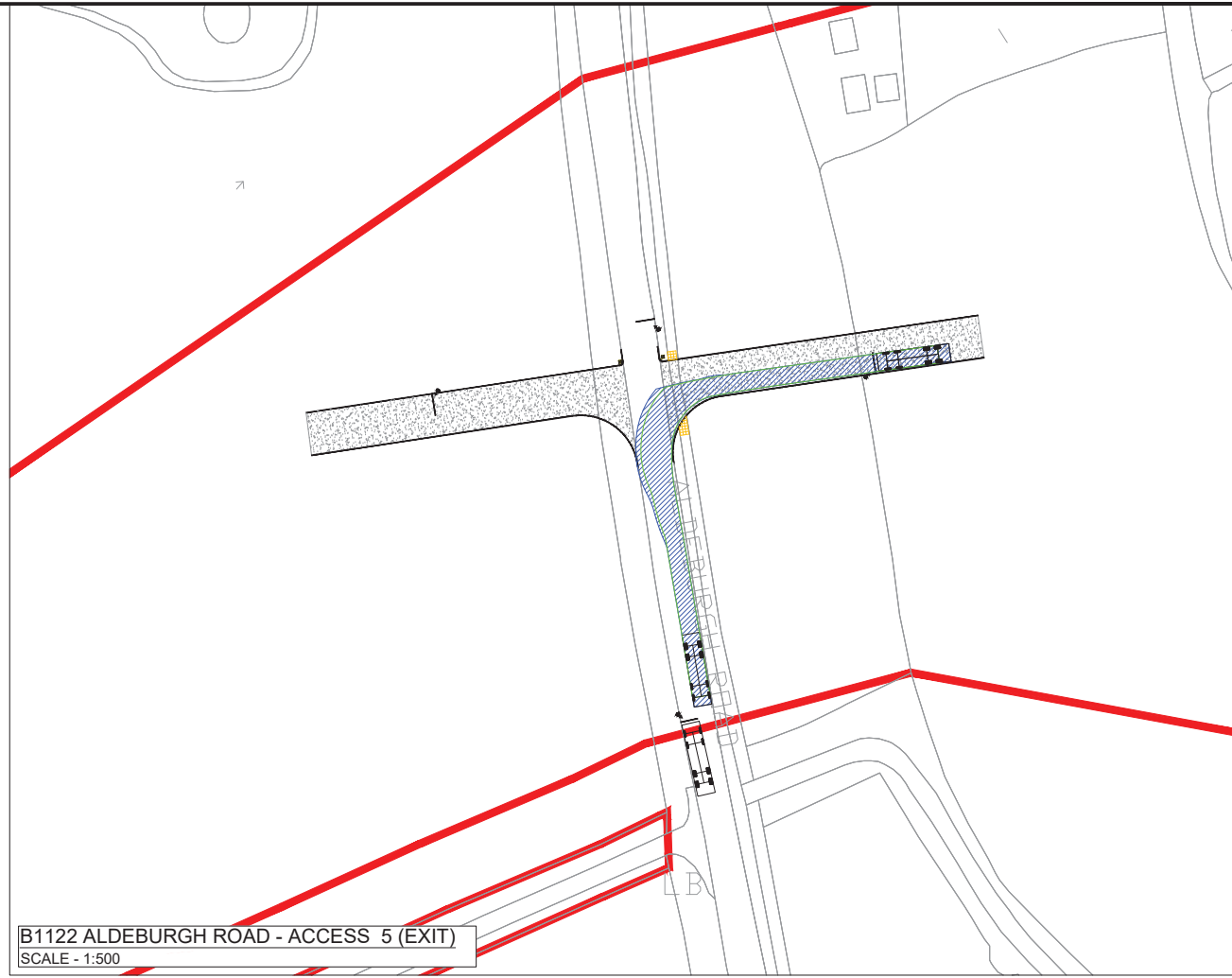

B1122 ALDEBURGH ROAD - ACCESS 5 (EXIT)
SCALE - 1:500

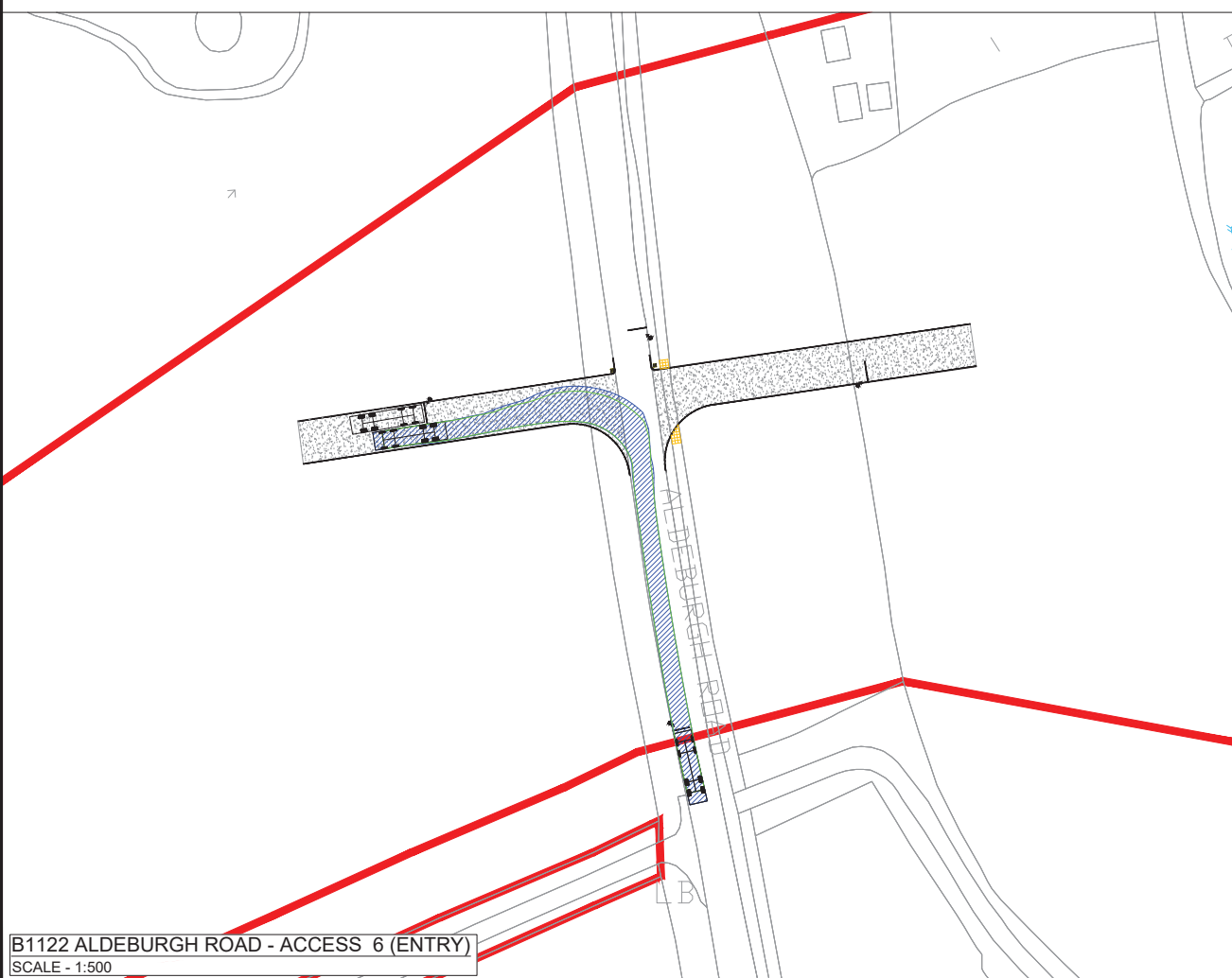

B1122 ALDEBURGH ROAD - ACCESS 6 (ENTRY)
SCALE - 1:500

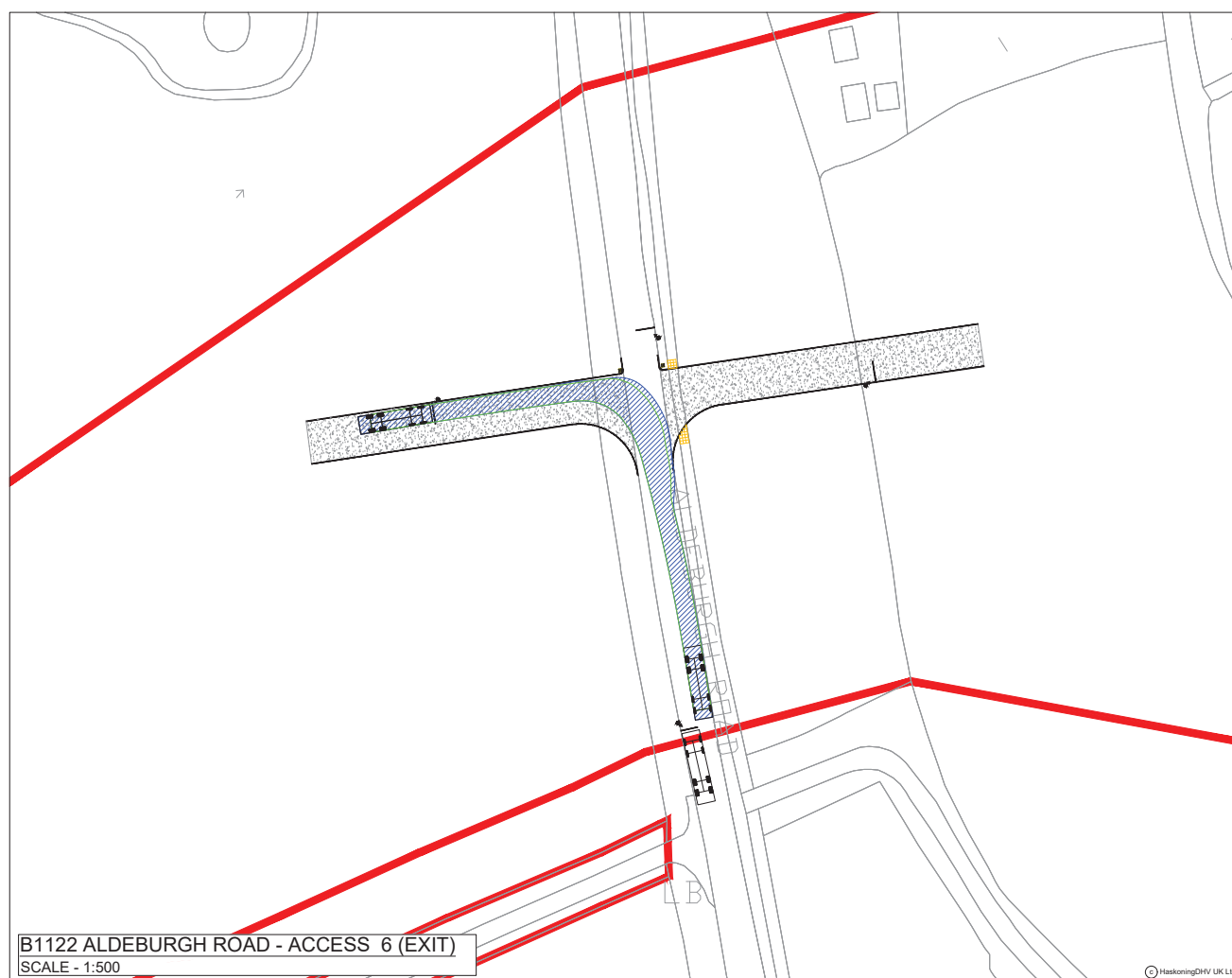

B1122 ALDEBURGH ROAD - ACCESS 6 (EXIT)
SCALE - 1:500

- NOTES**
- Do not scale from this drawing, all dimensions are in metres unless noted otherwise.
 - This drawing has been based upon Ordnance Survey Maps and Royal HaskoningDHV can not guarantee the accuracy of data.
- KEY**
- ORDER LIMITS
 - PROPOSED ACCESS BOUNDARY/ROAD MARKINGS
 - PROPOSED TEMPORARY TRAFFIC SIGNAL
 - PROPOSED BOLLARD

FULL DEPTH CARRIAGEWAY CONSTRUCTION WITH BOUND SURFACE

TACTILE PAVING

VEHICLE TRACKING

Large Tipper
Overall Length 10.20m
Overall Width 2.95m
Overall Body Height 5.60m
Min Body Ground Clearance 0.341m
Track Width 2.47m
Lock to lock time 6.00s
Kerb to Kerb Turning Radius 11.550m

- VEHICLE BODY SWEEP PATH (FORWARD GEAR)
- VEHICLE CHASSIS SWEEP PATH

| | | | | | |
|------|----------|---------------------------------------|----|-----|-----|
| D0.4 | 17.03.21 | ACCESS STRATEGY REVISED | JL | SKT | SKT |
| D0.3 | 24.07.18 | DRAWING TITLE AMENDED | JL | SKT | SKT |
| D0.2 | 11.06.18 | ORDER LIMITS, ACCESS LOCATION UPDATED | JL | SKT | SKT |
| D.01 | | FIRST ISSUE | | | |
| REV | DATE | DESCRIPTION | BY | CHK | APP |



PROJECT EAST ANGLIA TWO

TITLE SIGNAL CONTROLLED ACCESS 5 & 6
B1122 ALDEBURGH ROAD
LARGE TIPPER
SWEEP PATH ANALYSIS



| | | | | | |
|----------------|-----------------|-------------|----------|--------------|------|
| DRAWN | JL | CHECKED | SKT | APPROVED | ADR |
| DATE | 09.10.18 | SCALE AT A1 | AS SHOWN | AUTOCAD REF. | |
| DRAWING No. | TP-PB4842-DR010 | REVISION | | | |
| CLIENT DWG No. | | | | | D0.4 |

DRAWING No. TP-PB4842-DR030



VISIBILITY DETAILS
SCALE - 1:2000



ACCESS DETAILS
SCALE - 1:500

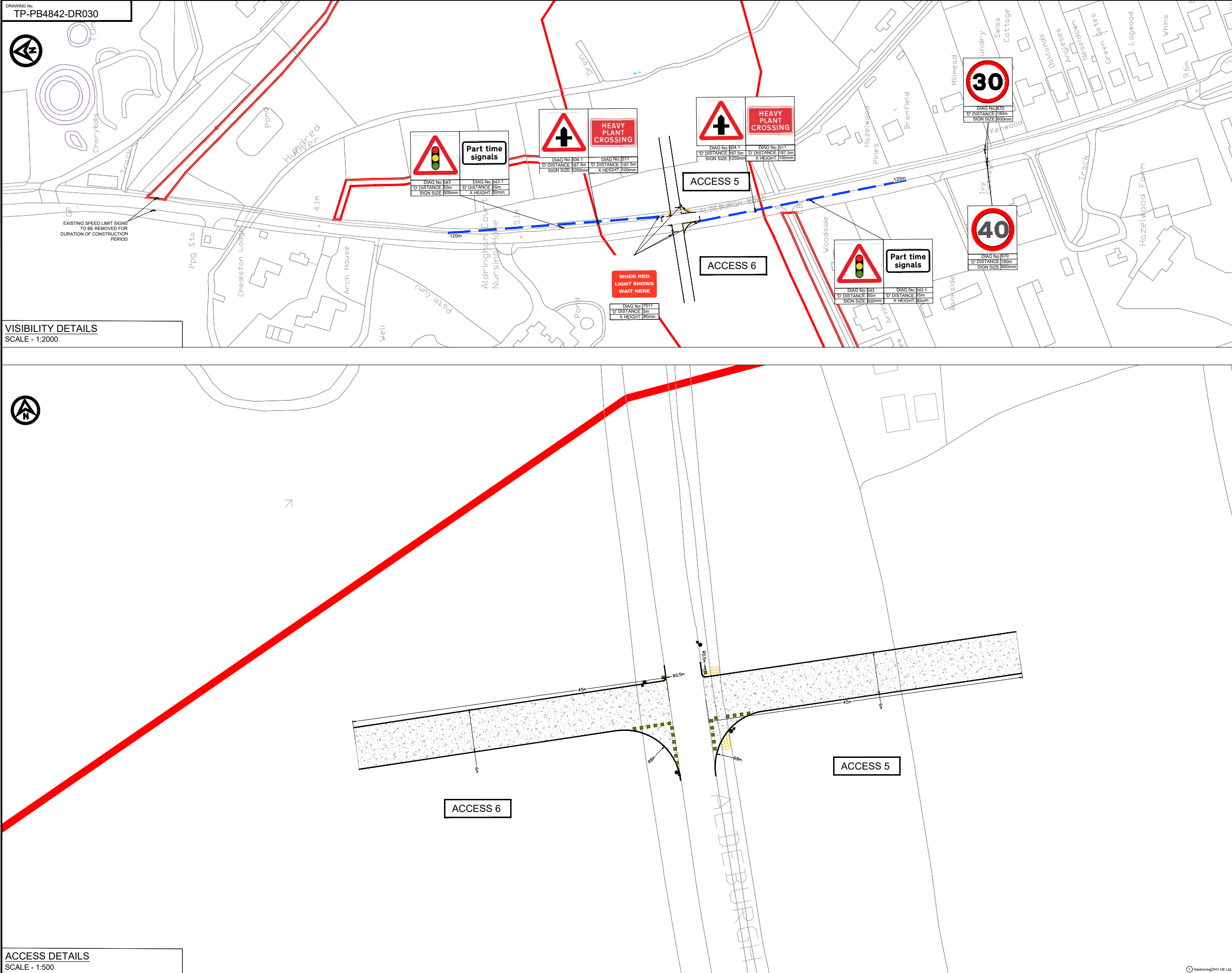

- NOTES**
- Do not scale from this drawing, all dimensions are in metres unless noted otherwise.
 - This drawing has been based upon Ordnance Survey Maps and Royal HaskoningDHV can not guarantee the accuracy of data.
 - All road markings and signage to conform with the 'Traffic Signs Regulation and General Directions 2016 and Chapter 8.
 - 'D' distance is the siting distance of temporary road signs from the closest haul road crossing point/access location.
 - SSD - Stopping Sight Distance for design speed of the road.
 - All vegetation to be cleared/trimmed within identified visibility envelope.

- KEY**
- ORDER LIMITS
 - PROPOSED ACCESS BOUNDARY/ROAD MARKINGS
 - VISIBILITY SPY (SEE VISIBILITY TABLE)
 - PROPOSED TEMPORARY ROAD SIGN
 - PROPOSED TEMPORARY TRAFFIC SIGNAL
 - PROPOSED BOLLARD
 - FULL DEPTH CARRIAGEWAY CONSTRUCTION WITH BOUND SURFACE
 - TACTILE PAVING

| ACCESS 5 - EAST SIDE OF B1122 (SOUTH OF ALDRINGHAM) | | VISIBILITY NORTH SOUTH | |
|---|------|--------------------------|-----|
| Posted Speed Limit (PSL) (mph) | 40 | | |
| Required Y-distance SSD for PSL (m) | 120 | | |
| Existing achievable Y-distance SSD (m) | 120 | Yes | Yes |
| Required Y-distance SSD achievable? | Yes | Yes | Yes |
| 85 th percentile speed (mph) | 44.7 | | |
| Required Y-distance SSD for 85 th percentile speed (m) | 120 | | |
| Existing Y-distance SSD suitable for 85 th percentile speeds | Yes | Yes | Yes |
| Proposed Reduced Speed Limit (RSL) (mph) | 30 | | |
| Assumed design speed (mph) | 30 | | |
| Required Y-distance SSD for design speed (m) | 90 | | |
| Required Y-distance SSD achievable? | Yes | Yes | Yes |
| Traffic control measures required | Yes | | |

| ACCESS 6 - WEST SIDE OF B1122 (SOUTH OF ALDRINGHAM) | | VISIBILITY NORTH SOUTH | |
|---|------|--------------------------|-----|
| Posted Speed Limit (PSL) (mph) | 40 | | |
| Required Y-distance SSD for PSL (m) | 120 | | |
| Existing achievable Y-distance SSD (m) | 120 | Yes | Yes |
| Required Y-distance SSD achievable? | Yes | Yes | Yes |
| 85 th percentile speed (mph) | 44.7 | | |
| Required Y-distance SSD for 85 th percentile speed (m) | 120 | | |
| Existing Y-distance SSD suitable for 85 th percentile speeds | Yes | Yes | Yes |
| Proposed Reduced Speed Limit (RSL) (mph) | 30 | | |
| Assumed design speed (mph) | 30 | | |
| Required Y-distance SSD for design speed (m) | 90 | | |
| Required Y-distance SSD achievable? | Yes | Yes | Yes |
| Traffic control measures required | Yes | | |

| REV | DATE | DESCRIPTION | BY | CHK | APP |
|------|------|-------------|----|-----|-----|
| D.01 | | FIRST ISSUE | | | |

CLIENT
SCOTTISHPOWER RENEWABLES

PROJECT
EAST ANGLIA TWO

TITLE
SIGNAL CONTROLLED CROSSING 5 & 6
B1122 ALDEBURGH ROAD

Royal HaskoningDHV
Enhancing Society Together

| DRAWN | JI | CHECKED | ST | APPROVED | ADR |
|----------------|-----------------|--------------------|--------------|----------|----------|
| DATE | 8.03.21 | SCALE AT AS VARIES | AUTOCAD REF. | | |
| DRAWING No. | TP-PB4842-DR030 | | | | REVISION |
| CLIENT DWG No. | | | | | D0.1 |

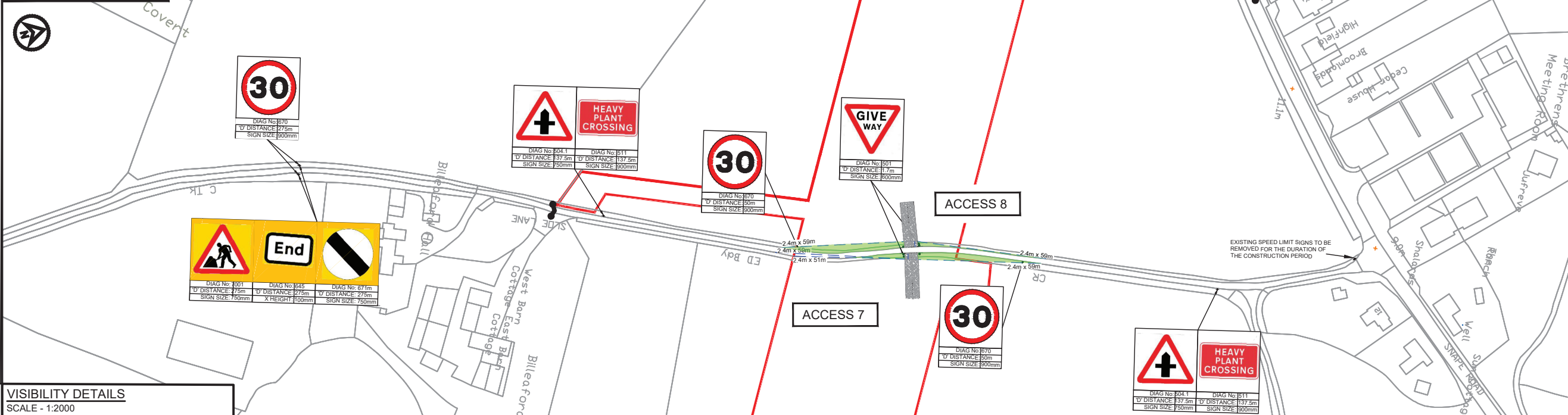

VISIBILITY DETAILS
SCALE - 1:2000



ACCESS DETAILS
SCALE - 1:500

NOTES
 1. Do not scale from this drawing, all dimensions are in metres unless noted otherwise.
 2. This drawing has been based upon Ordnance Survey Maps and Royal HaskoningDHV can not guarantee the accuracy of data.
Visibility
 3. X-distance - the set back from the nearest edge of the carriageway from which the access will be taken
 4. Y-distance - the SSD measured along the nearest edge of the carriageway to its intersection with the centreline of the access.
 5. SSD - Stopping Sight Distance for design speed of the road.
 6. All vegetation to be cleared/trimmed within identified visibility envelope.

- KEY**
- FULL DEPTH CARRIAGEWAY CONSTRUCTION WITH BOUND SURFACE
 - HEDGEROW REMOVAL REQUIRED TO ACCOMMODATE VISIBILITY
 - ORDER LIMITS
 - PROPOSED ACCESS BOUNDARY/ROAD MARKINGS
 - VISIBILITY PLAY (SEE VISIBILITY TABLE)
 - PROPOSED TEMPORARY ROAD SIGN

| ACCESS 7 - EAST SIDE OF SLOE LANE (NORTH OF KNORDISHALL COMMON) | VISIBILITY | |
|---|------------|---------|
| | EAST | WEST |
| Posted Speed Limit (PSL) (mph) | 30 | 215 |
| Required Y-distance SSD for PSL (m) | 12 | 101 |
| Existing achievable Y-distance SSD (m) | No | No |
| Required Y-distance SSD achievable? | No | No |
| Proposed Reduced Speed Limit (RSL) (mph) | 30 | 30 |
| Assumed design speed (mph) | 30 | 30 |
| Required Y-distance SSD for design speed (m) | 59 (M5) | 59 (M5) |
| Required Y-distance SSD achievable? | Yes | Yes |
| Traffic control measures required | Yes | Yes |

| ACCESS 8 - WEST SIDE OF SLOE LANE (NORTH OF KNORDISHALL COMMON) | VISIBILITY | |
|---|------------|---------|
| | EAST | WEST |
| Posted Speed Limit (PSL) (mph) | 30 | 215 |
| Required Y-distance SSD for PSL (m) | 12 | 101 |
| Existing achievable Y-distance SSD (m) | 91 | 19 |
| Required Y-distance SSD achievable? | No | No |
| Proposed Reduced Speed Limit (RSL) (mph) | 30 | 30 |
| Assumed design speed (mph) | 30 | 30 |
| Required Y-distance SSD for design speed (m) | 59 (M5) | 59 (M5) |
| Required Y-distance SSD achievable? | Yes | Yes |
| Traffic control measures required | Yes | Yes |

| REV | DATE | DESCRIPTION | BY | CHK | APP |
|------|----------|--|----|-----|-----|
| D0.3 | 09.12.20 | DRAWING TITLE AMENDED | JL | SKT | SKT |
| D0.2 | 24.07.19 | HEDGEROW REMOVAL AND PAGE SIZE AMENDED | JL | SKT | SKT |
| D.01 | | FIRST ISSUE | | | |



PROJECT
EAST ANGLIA TWO

TITLE
**ACCESS 7 & 8
SLOE LANE**



| DRAWN | JI | CHECKED | ST | APPROVED | ADR |
|----------------|-----------------|-------------|--------|--------------|----------|
| DATE | 12.06.19 | SCALE AT A3 | VARIES | AUTOCAD REF. | |
| DRAWING No. | TP-PB4842-DR027 | | | | REVISION |
| CLIENT DWG No. | | | | | D0.3 |

DRAWING No:
TP-PB4842-DR011

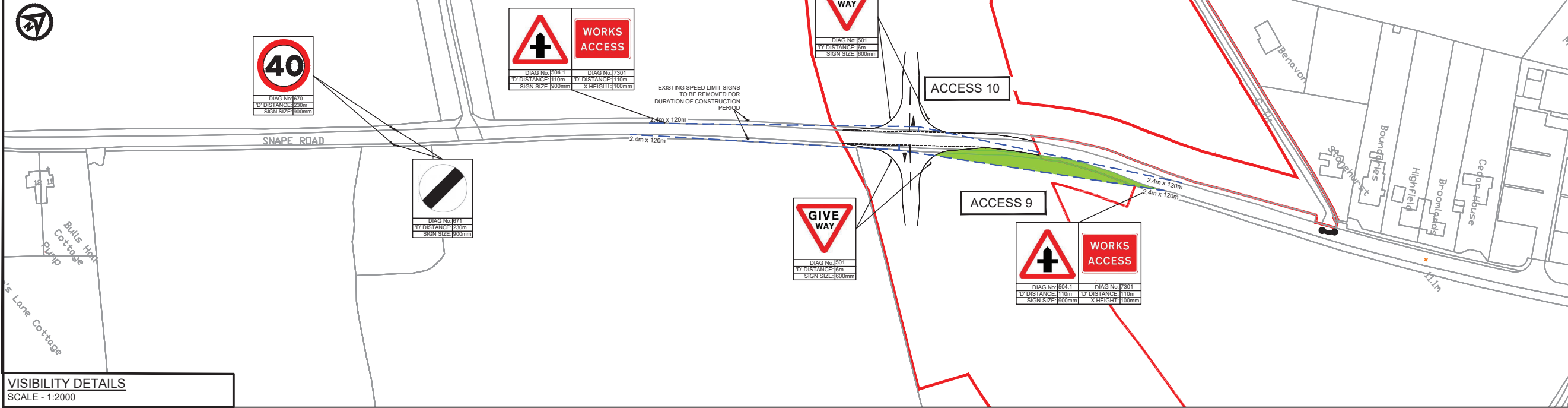

VISIBILITY DETAILS
SCALE - 1:2000

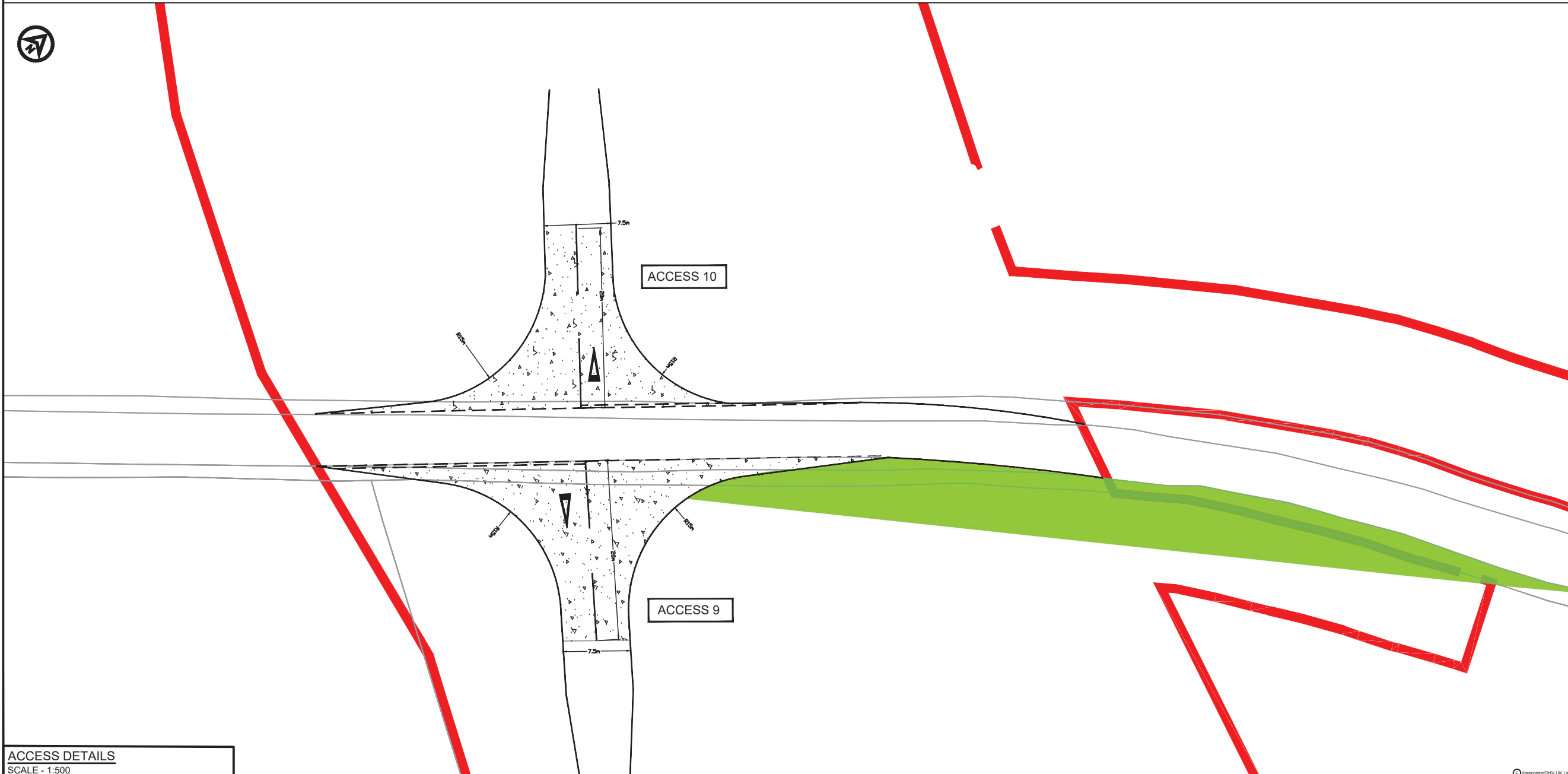

ACCESS DETAILS
SCALE - 1:500

- NOTES
- Do not scale from this drawing, all dimensions are in metres unless noted otherwise.
 - This drawing has been based upon Ordnance Survey Maps and Royal HaskoningDHV can not guarantee the accuracy of data.
 - All road markings and signage to conform with the Traffic Signs Regulation and General Directions 2016 and Chapter 8.
 - 'D' distance is the sighting distance of temporary road signs from the closest haul road crossing point/access location.
- Road markings and signs
- X-distance - the set back from the nearest edge of the carriageway from which the access will be taken
 - Y-distance - the SSD measured along the nearest edge of the carriageway to its intersection with the centreline of the access.
 - SSD - Stopping Sight Distance for design speed of the road.
 - All vegetation to be cleared/trimmed within identified visibility envelope.

- KEY
- FULL DEPTH CARRIAGEWAY CONSTRUCTION WITH BOUND SURFACE
 - HEDGEROW REMOVAL REQUIRED TO ACCOMMODATE VISIBILITY
 - ORDER LIMITS
 - PROPOSED ACCESS BOUNDARY/ROAD MARKINGS
 - VISIBILITY SPLAY (SEE VISIBILITY TABLE)
 - PROPOSED TEMPORARY ROAD SIGN

| ACCESS 9 - EAST SIDE OF B1069 (SOUTH OF COLDFAIR GREEN) | | VISIBILITY | |
|---|--|------------|-------|
| | | NORTH | SOUTH |
| Posted Speed Limit (PSL) (mph) | | 40 | |
| Required Y-distance SSD for PSL (m) | | 120 | |
| Existing achievable Y-distance SSD (m) | | 50 | 95 |
| Required Y-distance SSD achievable? | | No | No |
| 85 th percentile speed (mph) | | 39.4 | |
| Required Y-distance SSD for 85 th percentile speed (m) | | 120 | |
| Existing Y-distance SSD suitable for 85 th percentile speeds | | No | No |
| Proposed Reduced Speed Limit (RSL) (mph) | | 40 | |
| Assumed design speed (mph) | | 40 | |
| Required Y-distance SSD for design speed (m) | | 120 | |
| Required Y-distance SSD achievable? | | Yes | Yes |
| Traffic control measures required | | Yes | Yes |

| ACCESS 10 - WEST SIDE OF B1069 (SOUTH OF COLDFAIR GREEN) | | VISIBILITY | |
|---|--|------------|-------|
| | | NORTH | SOUTH |
| Posted Speed Limit (PSL) (mph) | | 40 | |
| Required Y-distance SSD for PSL (m) | | 120 | |
| Existing achievable Y-distance SSD (m) | | 145 | 268 |
| Required Y-distance SSD achievable? | | Yes | Yes |
| 85 th percentile speed (mph) | | 39.4 | |
| Required Y-distance SSD for 85 th percentile speed (m) | | 120 | |
| Existing Y-distance SSD suitable for 85 th percentile speeds | | Yes | Yes |
| Proposed Reduced Speed Limit (RSL) (mph) | | 40 | |
| Assumed design speed (mph) | | 40 | |
| Required Y-distance SSD for design speed (m) | | 120 | |
| Required Y-distance SSD achievable? | | Yes | Yes |
| Traffic control measures required | | Yes | Yes |

| REV | DATE | DESCRIPTION | BY | CHK | APP |
|------|----------|---------------------------------------|----|-----|-----|
| D0.5 | 16.02.21 | ACCESS LOCATION REVISED | JL | SKT | SKT |
| D0.4 | 24.07.19 | PAGE SIZE CHANGED FROM A3 TO A1 | JL | SKT | SKT |
| D0.3 | 27.06.19 | ORDER LIMITS, ACCESS LOCATION UPDATED | JL | SKT | SKT |
| D0.2 | 16.11.18 | ORDER LIMITS UPDATED | JL | SKT | ADR |
| D.01 | | FIRST ISSUE | | | |

CLIENT

PROJECT

EAST ANGLIA TWO

TITLE

ACCESS 9 & 10
SNAPE ROAD

Enterprise House,
Delta Way, Egham,
Surrey, TW20 8RQ
Tel +44(0)1932 569568
www.royalhaskoningdhv.com

| DRAWN | CHECKED | APPROVED |
|-----------------------------|-------------|--------------|
| DATE | SCALE AT A3 | AUTOCAD REF. |
| JL | ST | ADR |
| 09.10.18 | VARIES | |
| DRAWING No: TP-PB4842-DR011 | REVISION | |
| CLIENT DWG No. | | D0.5 |



DRAWING No.
TP-PB4842-DR012



ACCESS 9

SNAPE ROAD - ACCESS 9
SCALE - 1:200

NOTES
1. Do not scale from this drawing, all dimensions are in metres unless noted otherwise.
2. This drawing has been based upon Ordnance Survey Maps and Royal HaskoningDHV can not guarantee the accuracy of data.



KEY
 ORDER LIMITS
 PROPOSED ACCESS BOUNDARY/ROAD MARKINGS

 FULL DEPTH CARRIAGEWAY CONSTRUCTION WITH BOUND SURFACE

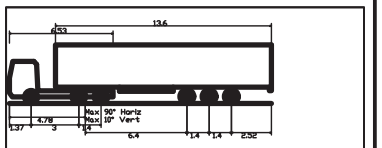
VEHICLE TRACKING



Max Legal Length (UK) Articulated Vehicle (16.5m)
 Overall Length 16.50m
 Overall Width 2.55m
 Overall Body Height 3.68m
 Min Body Ground Clearance 0.41m
 Max Track Width 2.50m
 Lock to lock time 6.80s
 Kerb to kerb turning Radius 6.55m

 VEHICLE BODY SWEEP PATH (FORWARD GEAR)
 VEHICLE CHASSIS SWEEP PATH

| | | | | | |
|------|----------|---------------------------------------|----|-----|-----|
| D0.4 | 18.02.21 | ACCESS LOCATION REVISED | JL | SKT | SKT |
| D0.3 | 24.07.19 | DRAWING TITLE AMENDED | JL | SKT | SKT |
| D0.2 | 27.06.19 | ORDER LIMITS, ACCESS LOCATION UPDATED | JL | SKT | SKT |
| D.01 | | FIRST ISSUE | | | |
| REV | DATE | DESCRIPTION | BY | CHK | APP |

REVISIONS

CLIENT



PROJECT

EAST ANGLIA TWO

TITLE

ACCESS 9
SNAPE ROAD
MAX ARTICULATED HGV
SWEEP PATH ANALYSIS
(RIGHT TURN IN / LEFT TURN OUT)



DRAWN JL CHECKED SKT APPROVED ADR

DATE 09.10.18 SCALE AT A3 1:200 AUTOCAD REF.

DRAWING No. TP-PB4842-DR012 REVISION D0.4

CLIENT DWG No.

DRAWING No.
TP-PB4842-DR013

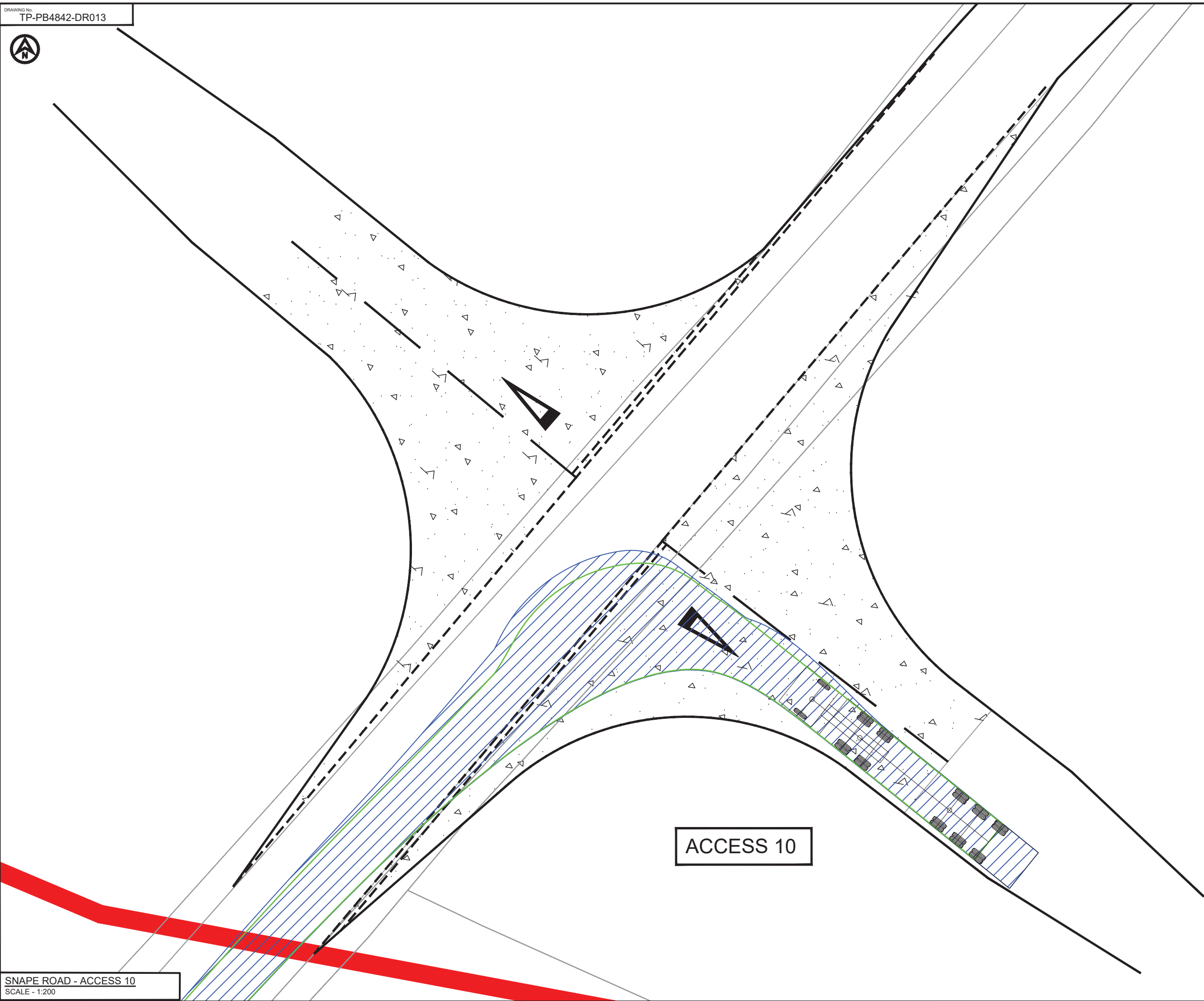

SNAPE ROAD - ACCESS 10
SCALE - 1:200

NOTES
1. Do not scale from this drawing, all dimensions are in metres unless noted otherwise.
2. This drawing has been based upon Ordnance Survey Maps and Royal HaskoningDHV can not guarantee the accuracy of data.

KEY
 ORDER LIMITS
 PROPOSED ACCESS BOUNDARY/ROAD MARKINGS

FULL DEPTH CARRIAGEWAY CONSTRUCTION WITH BOUND SURFACE

VEHICLE TRACKING

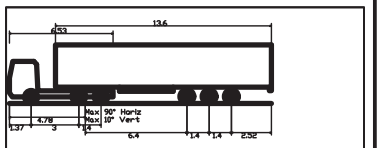

Max Legal Length (UK) Articulated Vehicle (16.5m)
 Overall Length 16.50m
 Overall Width 3.25m
 Overall Body Height 3.81m
 Min Body Ground Clearance 0.41m
 Max Track Width 2.50m
 Lock to Lock Time 6.80s
 Kerb to Kerb Turning Radius 6.55m

VEHICLE BODY SWEEP PATH (FORWARD GEAR)
 VEHICLE CHASSIS SWEEP PATH

| | | | | | |
|------|----------|---------------------------------------|----|-----|-----|
| D0.4 | 18.02.21 | ACCESS LOCATION REVISED | JL | SKT | SKT |
| D0.3 | 24.07.19 | DRAWING TITLE AMENDED | JL | SKT | SKT |
| D0.2 | 27.06.19 | ORDER LIMITS, ACCESS LOCATION UPDATED | JL | SKT | SKT |
| D.01 | | FIRST ISSUE | | | |
| REV | DATE | DESCRIPTION | BY | CHK | APP |

REVISIONS

CLIENT



PROJECT

EAST ANGLIA TWO

TITLE

ACCESS 10
SNAPE ROAD
MAX ARTICULATED HGV
SWEEP PATH ANALYSIS
(LEFT TURN OUT)



| | | | | | |
|-------|----|---------|-----|----------|-----|
| DRAWN | JL | CHECKED | SKT | APPROVED | ADR |
|-------|----|---------|-----|----------|-----|

DATE 09.10.18 SCALE AT A3 1:200 AUTOCAD REF.

| | | | |
|----------------|-----------------|----------|------|
| DRAWING No. | TP-PB4842-DR013 | REVISION | D0.4 |
| CLIENT DWG No. | | | |

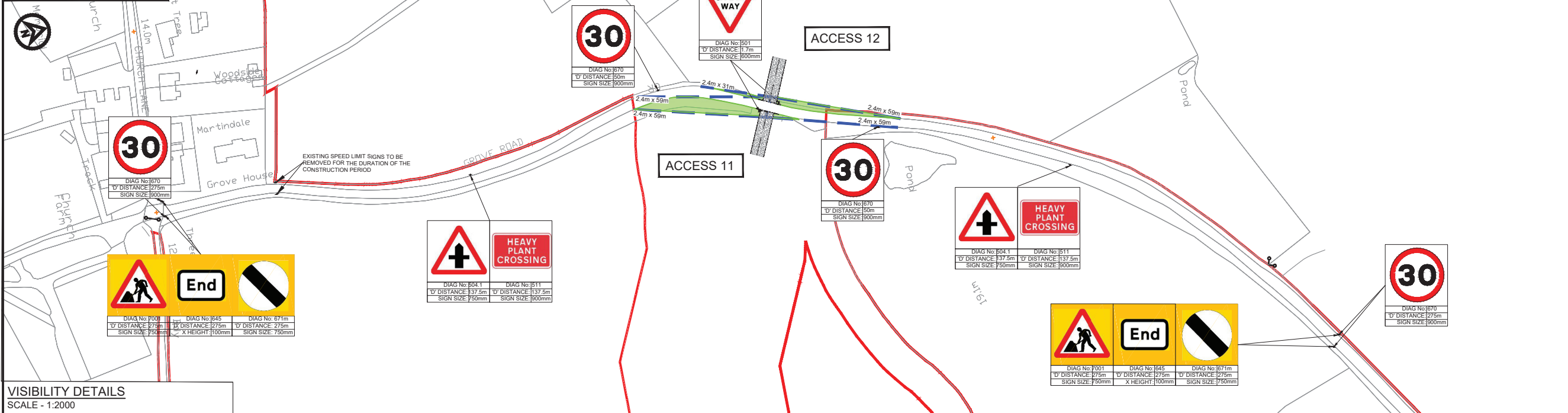

VISIBILITY DETAILS
SCALE - 1:2000



ACCESS DETAILS
SCALE - 1:500

NOTES
 1. Do not scale from this drawing, all dimensions are in metres unless noted otherwise.
 2. This drawing has been based upon Ordnance Survey Maps and Royal HaskoningDHV can not guarantee the accuracy of data.
Visibility
 3. X-distance - the set back from the nearest edge of the carriageway from which the access will be taken
 4. Y-Distance - the SSD measured along the nearest edge of the carriageway to its intersection with the centreline of the access.
 5. SSD - Stopping Sight Distance for design speed of the road.
 6. All vegetation to be cleared/trimmed within identified visibility envelope.

KEY

 FULL DEPTH CARRIAGEWAY CONSTRUCTION WITH BOUND SURFACE
 HEDGEROW REMOVAL REQUIRED TO ACCOMMODATE VISIBILITY
 ORDER LIMITS
 PROPOSED ACCESS BOUNDARY/ROAD MARKINGS
 VISIBILITY SPLAY (SEE VISIBILITY TABLE)
 PROPOSED SPEED VISIBILITY SPLAY
 PROPOSED TEMPORARY ROAD SIGN

| ACCESS 11 - EAST SIDE OF GROVE ROAD (NORTH OF FRISTON) | | VISIBILITY | |
|---|--|------------|------|
| | | EAST | WEST |
| Posted Speed Limit (PSL) (mph) | | 60 | 215 |
| Required Y-distance SSD for PSL (m) | | 35 | 45 |
| Existing achievable Y-distance SSD (m) | | No | No |
| Required Y-distance SSD achievable? | | No | No |
| 85 th percentile speed (mph) | | 31.9 | |
| Required Y-distance SSD for 85 th percentile speed (m) | | 59 (M5) | |
| Proposed Reduced Speed Limit (RSL) (mph) | | 30 | |
| Required Y-distance SSD for design speed (m) | | 59 | |
| Required Y-distance SSD achievable? | | Yes | Yes |
| Traffic control measures required | | Yes | Yes |

Y Distances measured on site.

| ACCESS 12 - WEST SIDE OF GROVE ROAD (NORTH OF FRISTON) | | VISIBILITY | |
|---|--|------------|------|
| | | EAST | WEST |
| Posted Speed Limit (PSL) (mph) | | 60 | 215 |
| Required Y-distance SSD for PSL (m) | | 35 | 45 |
| Existing achievable Y-distance SSD (m) | | 0 | 0 |
| Required Y-distance SSD achievable? | | No | No |
| 85 th percentile speed (mph) | | 31.9 | |
| Required Y-distance SSD for 85 th percentile speed (m) | | 59 (M5) | |
| Proposed Reduced Speed Limit (RSL) (mph) | | 30 | |
| Required Y-distance SSD for design speed (m) | | 59 | |
| Required Y-distance SSD achievable? | | Yes | Yes |
| Traffic control measures required | | Yes | Yes |

Y Distances measured on site.

| REV | DATE | DESCRIPTION | BY | CHK | APP |
|------|----------|---------------------------------|----|-----|-----|
| D0.4 | 04.07.19 | PAGE SIZE CHANGED FROM A3 TO A1 | J | SKT | SKT |
| D0.3 | 12.06.19 | ORDER LIMITS UPDATED | J | SKT | SKT |
| D0.2 | 16.11.18 | ORDER LIMITS UPDATED | J | SKT | ADR |
| D.01 | | FIRST ISSUE | | | |

REVISIONS

CLIENT

SCOTTISHPOWER RENEWABLES

PROJECT

EAST ANGLIA TWO

TITLE

ACCESS 11 & 12 GROVE ROAD

Royal HaskoningDHV
Enhancing Society Together

Enterprise House, Delta Way, Egham, Surrey, TW20 8FX
Tel: +44(0)1323 589566
www.royalhaskoningdhv.com

| | | | | | |
|----------------|-----------------|-------------|-----------|--------------|----------|
| DRAWN | JI | CHECKED | ST | APPROVED | ADR |
| DATE | 09.10.18 | SCALE AT A3 | VARIABLES | AUTOCAD REF. | |
| DRAWING No. | TP-PB4842-DR014 | | | | REVISION |
| CLIENT DWG No. | | | | | D0.4 |

DRAWING No.
TP-PB4842-DR020

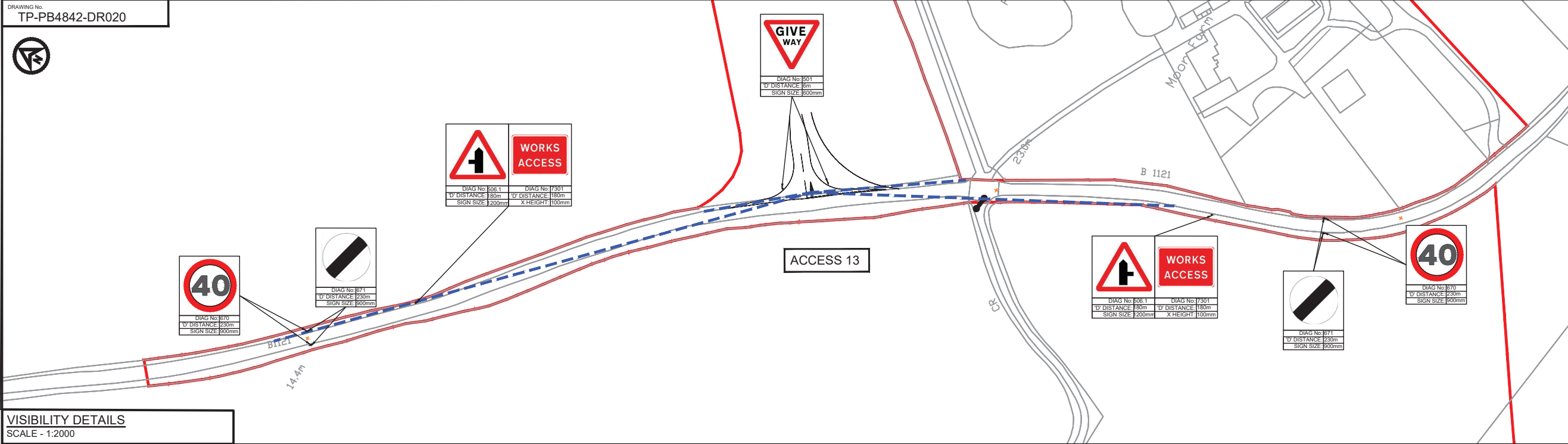

VISIBILITY DETAILS
SCALE - 1:2000



ACCESS DETAILS
SCALE - 1:200

- NOTES**
- Do not scale from this drawing, all dimensions are in metres unless noted otherwise.
 - This drawing has been based upon Ordnance Survey Maps and Royal HaskoningDHV can not guarantee the accuracy of data.
- Road markings and signs**
- All road markings and signage to conform with the Traffic Signs Regulation and General Directions 2016 and Chapter 8.
 - 'D' distance is the siting distance of temporary road signs from the closest haul road crossing point/access location.
- Visibility**
- X-distance - the set back from the nearest edge of the carriageway from which the access will be taken
 - Y-Distance - the SSD measured along the nearest edge of the carriageway to its intersection with the centreline of the access.
 - SSD- Stopping Sight Distance for design speed of the road.
 - All vegetation to be cleared/trimmed within identified visibility envelope.

- KEY**
- PROPOSED ACCESS BOUNDARY/ROAD MARKINGS
 - VISIBILITY SPLAY (SEE VISIBILITY TABLE)
 - PROPOSED TEMPORARY ROAD SIGN
 - FULL DEPTH CARRIAGEWAY CONSTRUCTION WITH BOUND SURFACE
 - INDICATIVE ABNORMAL LOAD VEHICLE OVERRUN AREA

| ACCESS 13 - B1121 | | VISIBILITY | |
|---|-----|------------|-------|
| | | NORTH | SOUTH |
| Posted Speed Limit (PSL) (mph) | | | 60 |
| Required Y-distance SSD for PSL (m) | | | 215 |
| Existing achievable Y-distance SSD (m) | | | 247 |
| Required Y-distance SSD achievable? | Yes | No | 161 |
| 85th percentile speed (mph) | | | 43.8 |
| Required Y-distance SSD for 85th percentile speed (m) | | | 160 |
| Existing Y-distance SSD suitable for 85th percentile speeds | Yes | Yes | |
| Proposed Reduced Speed Limit (RSL) (mph) | | | 40 |

Distances measured on site.

| REV | DATE | DESCRIPTION | BY | CHK | APP |
|------|----------|---------------------------------|----|-----|-----|
| D0.4 | 19.12.20 | DRAWING TITLE AMENDED | JL | SKT | SKT |
| D0.3 | 24.07.19 | PAGE SIZE CHANGED FROM A3 TO A1 | JL | SKT | SKT |
| D0.2 | 12.06.19 | ORDER LIMITS UPDATED | JL | SKT | SKT |
| D.01 | | FIRST ISSUE | | | |

REVISIONS

CLIENT



PROJECT

EAST ANGLIA TWO

TITLE

ACCESS 13
B1121 SAXMUNDHAM ROAD
CONSTRUCTION PHASE

DRAWN



CHECKED

APPROVED

DATE

DRAWING No. TP-PB4842-DR020

REVISION

D0.4

DRAWING No
TP-PB4842-DR021

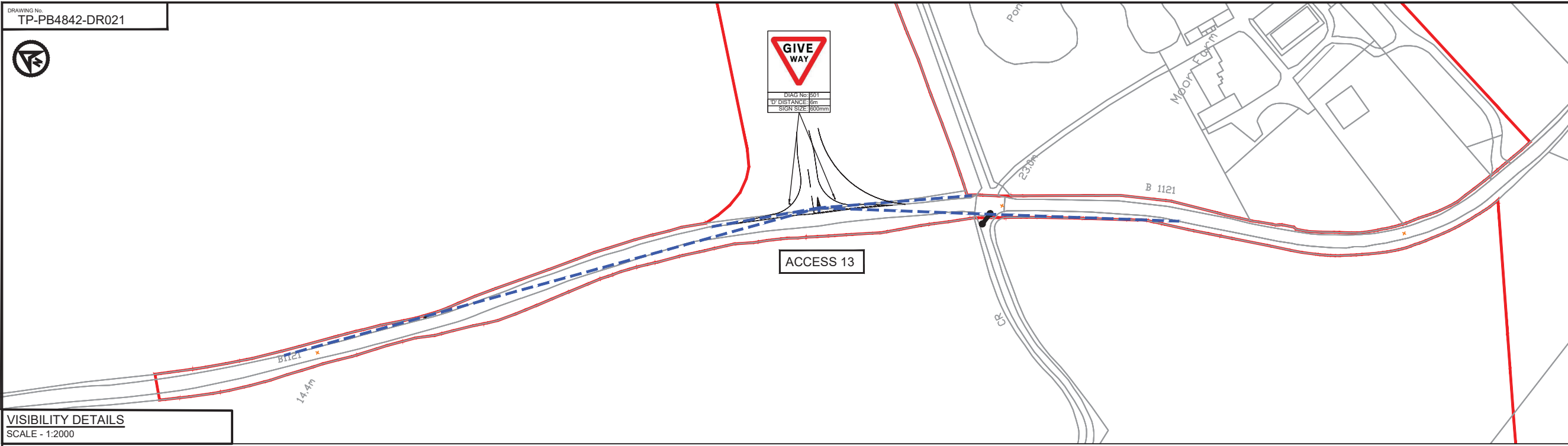

VISIBILITY DETAILS
SCALE - 1:2000



ACCESS DETAILS
SCALE - 1:500

- NOTES**
1. Do not scale from this drawing, all dimensions are in metres unless noted otherwise.
 2. This drawing has been based upon Ordnance Survey Maps and Royal HaskoningDHV can not guarantee the accuracy of data.
 3. All road markings and signage to conform with the Traffic Signs Regulation and General Directions 2016 and Chapter 8.
 4. 'D' distance is the siting distance of temporary road signs from the closest haul road crossing point/access location.
- Road markings and signs**
5. X-distance - the set back from the nearest edge of the carriageway from which the access will be taken
 6. Y-Distance - the SSD measured along the nearest edge of the carriageway to its intersection with the centreline of the access.
 7. SSD - Stopping Sight Distance for design speed of the road.
 8. All vegetation to be cleared/trimmed within identified visibility envelope.

KEY

- PROPOSED ACCESS BOUNDARY/ROAD MARKINGS
- VISIBILITY SPLAY (SEE VISIBILITY TABLE)
- PROPOSED ROAD SIGN
- FULL DEPTH CARRIAGEWAY CONSTRUCTION WITH BOUND SURFACE
- INDICATIVE ABNORMAL LOAD VEHICLE OVERRUN AREA

| ACCESS 13 - B1121 | VISIBILITY | |
|---|------------|-------|
| | NORTH | SOUTH |
| Posted Speed Limit (PSL) (mph) | 60 | |
| Required Y-distance SSD for PSL (m) | 215 | |
| Existing achievable Y-distance SSD (m) | 247 | 161 |
| Required Y-distance SSD achievable? | Yes | No |
| 85 th percentile speed (mph) | 43.8 | |
| Required Y-distance SSD for 85 th percentile speed (m) | 160 | |
| Existing Y-distance SSD suitable for 85 th percentile speeds | Yes | Yes |

*Distances measured on site.

| REV | DATE | DESCRIPTION | BY | CHK | APP |
|------|----------|---------------------------------|----|-----|-----|
| D0.4 | 09.12.20 | DRAWING TITLE AMENDED | JL | SKT | SKT |
| D0.3 | 24.07.19 | PAGE SIZE CHANGED FROM A3 TO A1 | JL | SKT | SKT |
| D0.2 | 12.06.19 | ORDER LIMITS UPDATED | JL | SKT | SKT |
| D.01 | | FIRST ISSUE | | | |



PROJECT
EAST ANGLIA TWO

TITLE
ACCESS 13
B1121 SAXMUNDHAM ROAD
OPERATIONAL PHASE



| DRAWN | JI | CHECKED | ST | APPROVED | ADR |
|----------------|-----------------|-------------|-----------|--------------|----------|
| DATE | 13.11.18 | SCALE AT A3 | VARIABLES | AUTOCAD REF. | |
| DRAWING No | TP-PB4842-DR021 | | | | REVISION |
| CLIENT DWG No. | | | | | D0.4 |

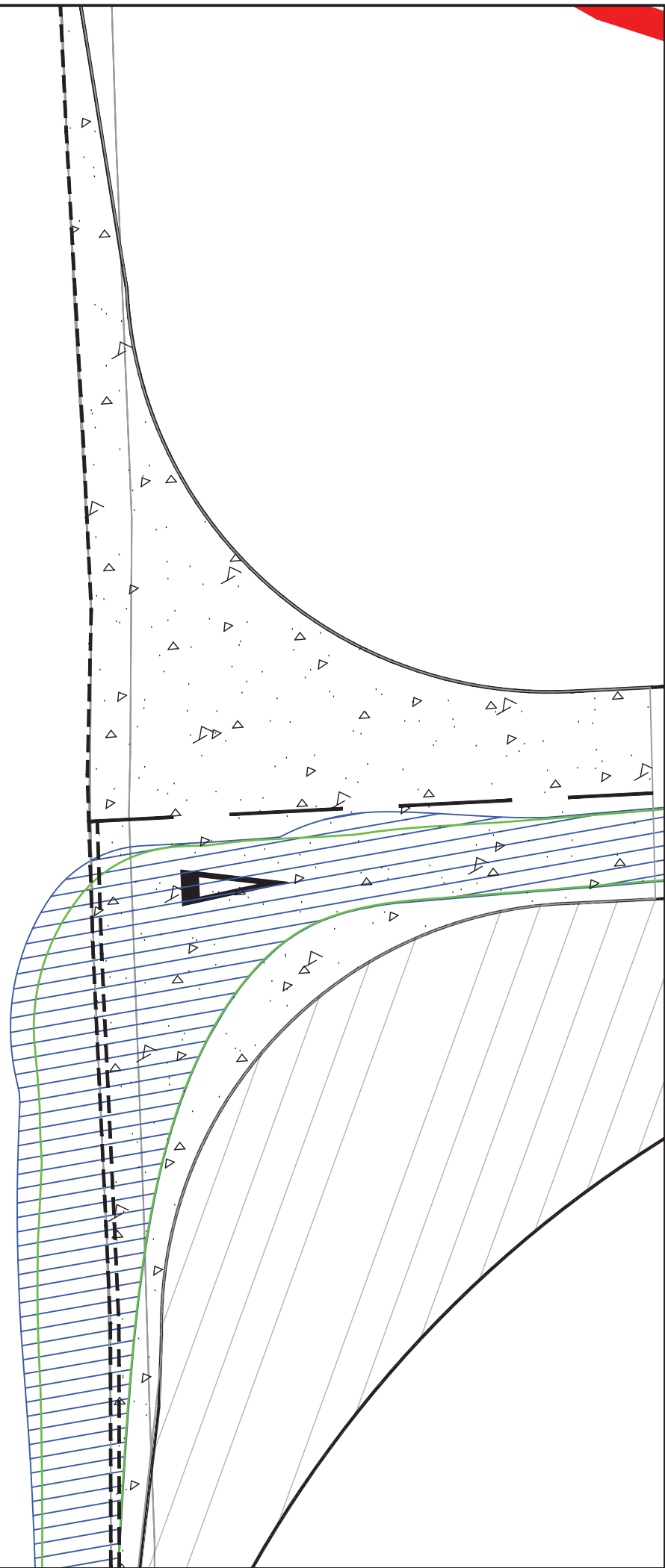

B1121 - ACCESS 13
SCALE - 1:200

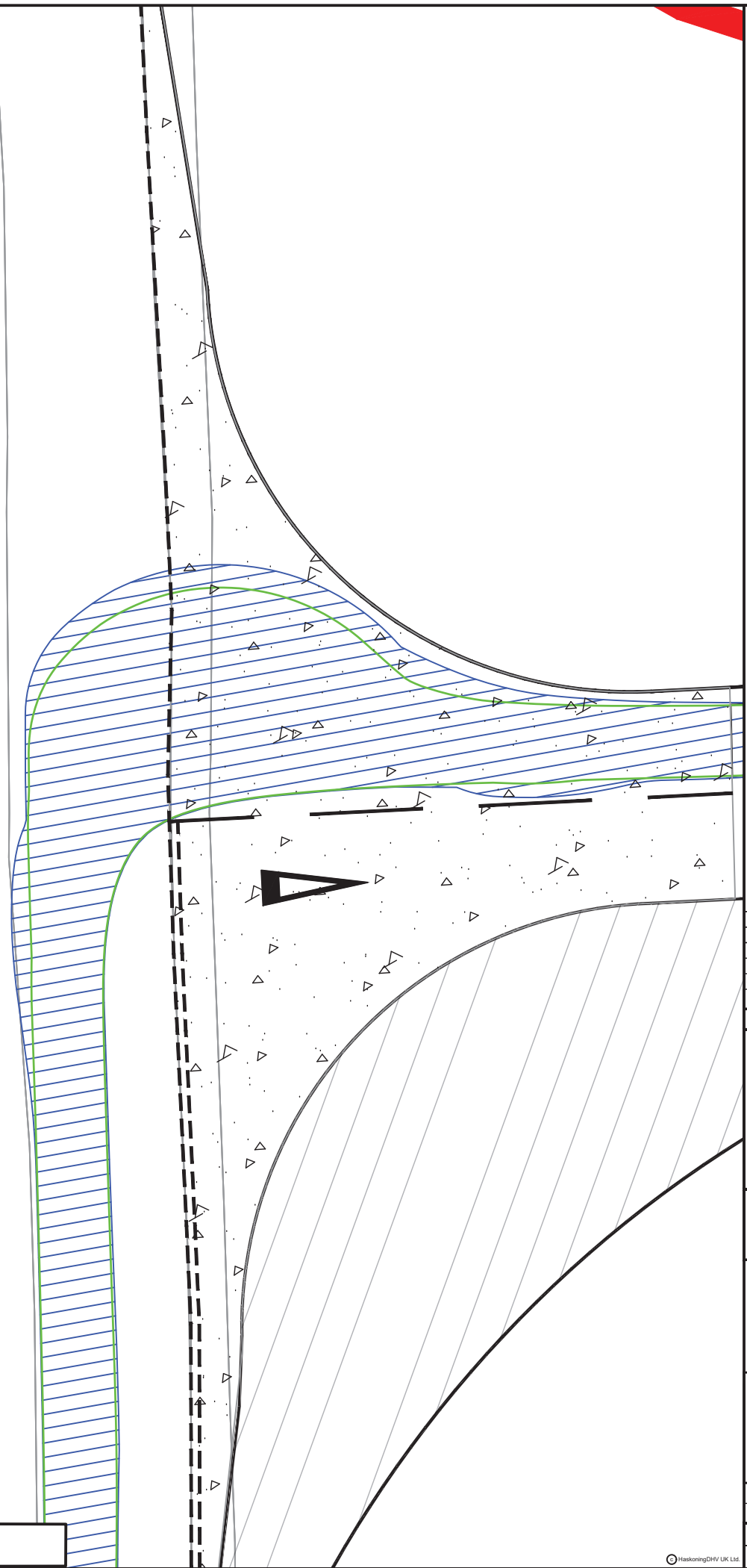

B1121 - ACCESS 13
SCALE - 1:200

NOTES
1. Do not scale from this drawing, all dimensions are in metres unless noted otherwise.
2. This drawing has been based upon Ordnance Survey Maps and Royal HaskoningDHV can not guarantee the accuracy of data.

KEY
 ORDER LIMITS
 PROPOSED ACCESS BOUNDARY/ROAD MARKINGS
 FULL DEPTH CARRIAGEWAY CONSTRUCTION WITH BOUND SURFACE

VEHICLE TRACKING

| | |
|---|--------|
| Max Legal Length (UK) Articulated Vehicle (16.5m) | 16.50m |
| Overall Length | 16.50m |
| Overall Width | 5.25m |
| Overall Body Height | 5.25m |
| Min Body Ground Clearance | 0.41m |
| Max Track Width | 2.50m |
| Lock to Lock Time | 6.00s |
| Kerb to Kerb Turning Radius | 6.530m |

VEHICLE BODY SWEEP PATH (FORWARD GEAR)
 VEHICLE CHASSIS SWEEP PATH

| | | | | | |
|------|----------|--------------------------|----|-----|-----|
| D0.5 | 22.02.21 | VEHICLE TRACKING REVISED | JL | SKT | SKT |
| D0.4 | 09.12.20 | DRAWING TITLE AMENDED | JL | SKT | SKT |
| D0.3 | 24.07.19 | DRAWING TITLE AMENDED | JL | SKT | SKT |
| D0.2 | 12.06.19 | ORDER LIMITS UPDATED | JL | SKT | SKT |
| D.01 | | FIRST ISSUE | | | |
| REV | DATE | DESCRIPTION | BY | CHK | APP |

REVISIONS

CLIENT



PROJECT
EAST ANGLIA TWO

TITLE
ACCESS 13
B1121 SAXMUNDHAM ROAD
MAX ARTICULATED HGV
SWEEP PATH ANALYSIS



| | | | | | |
|----------------|-----------------|-------------|-------|--------------|------|
| DRAWN | JL | CHECKED | SKT | APPROVED | ADR |
| DATE | 13.11.18 | SCALE AT A3 | 1:200 | AUTOCAD REF. | |
| DRAWING No. | TP-PB4842-DR022 | REVISION | | | |
| CLIENT DWG No. | | | | | D0.5 |



Annex 3: Stage 1 Road Safety Audit and Designers Response

ROAD SAFETY AUDIT – DESIGNER’S RESPONSE

| | |
|---------------------------|-----------------------------------|
| Project | East Anglia TWO Offshore Windfarm |
| Audit Reference | T&P PB4842 RSA1 |
| Date of Audit | 17.07.2019 |
| Audit Team Members | [REDACTED] |

| Paragraph No. / Problem No. | Problem Accepted (Yes / No) | Recommended Measure Accepted (Yes / No) | Notes, alternative Measure (describe) |
|-----------------------------|-----------------------------|---|---|
| B1.1.1 / Problem 1 | Yes | Yes | Details of a relocated bus stop will be provided for the Stage 2 Road Safety Audit (RSA) |
| B1.2.1 / Problem 2 | Yes | Yes | Detail of surfacing materials will be provided for the Stage 2 RSA. |
| B2.2.1 / Problem 3 | Yes | Yes | The Access Management Plan includes a requirement for the Contractor to maintain visibility splays for the duration of use of the access. |
| B2.3.1 / Problem 4 | Yes | Yes | Details of the location of utilities' and any required diversions will be provided for the Stage 2 RSA. |
| B5.1.1 / Problem 5 | Yes | Yes | Details of relocated signing will be provided for the Stage 2 RSA. |
| B5.1.2 / Problem 6 | Yes | Yes | Details of signing sizes and carriageway offsets will be provided for the Stage 2 RSA. |
| B5.1.3 / Problem 7 | Yes | Yes | Details of signing sizes and carriageway offsets will be provided for the Stage 2 RSA. |
| B5.1.4 / Problem 8 | Yes | Yes | Details of relocated signing will be provided for the Stage 2 RSA. |
| B5.1.5 / Problem 9 | Yes | Yes | Details of signing sizes and carriageway offsets will be provided for the Stage 2 RSA. |
| B5.2.1 / Problem 10 | Yes | Yes | Details of amendments of the center line markings will be provided for the Stage 2 RSA |

Signed: [REDACTED]

Date: 30.07.2019

Name: [REDACTED]

Please submit this completed Designer’s Response to the Local Highway Authority, in conjunction with the associated Road Safety Audit.

East Anglia TWO Offshore Windfarm

Stage 1 Road Safety Audit

Client: Scottish PowerRenewables

Reference: T&P PB4842 RSA1

Status: 01/Final

Date: 30 July 2019

HASKONINGDHV UK LTD.

Newater House
11 Newhall Street
Birmingham
B3 3NY
Transport UK
VAT registration number: 792428892

+44 121 7096520 **T**
info.birmingham@uk.rhdhv.com **E**
royalhaskoningdhv.com **W**

Document title: East Anglia TWO Offshore Windfarm

Document short title: East Anglia TWO - RSA1
Reference: T&P PB4842 RSA1
Status: 01/Final
Date: 30 July 2019
Project name: East Anglia TWO Offshore Windfarm
Project number: PB4842
Author(s): [REDACTED]

Drafted by: [REDACTED]

Checked by: [REDACTED]

Date / initials: 05.07.2019 / BB

Approved by: [REDACTED]

Date / initials: 17.07.2019

Classification

Project related



Disclaimer

No part of these specifications/printed matter may be reproduced and/or published by print, photocopy, microfilm or by any other means, without the prior written permission of HaskoningDHV UK Ltd.; nor may they be used, without such permission, for any purposes other than that for which they were produced. HaskoningDHV UK Ltd. accepts no responsibility or liability for these specifications/printed matter to any party other than the persons by whom it was commissioned and as concluded under that Appointment. The integrated QHSE management system of HaskoningDHV UK Ltd. has been certified in accordance with ISO 9001:2015, ISO 14001:2015 and OHSAS 18001:2007.

Table of Contents

| | | |
|----------|--|----------|
| 1 | Introduction | 1 |
| 2 | Matters Arising from this Stage 1 Road Safety Audit | 3 |
| B1 | Local Alignment | 3 |
| B2 | General | 4 |
| B3 | Junctions | 5 |
| B4 | Walking, Cycling and Horse Riding | 5 |
| B5 | Traffic Signs, Carriageway Markings and Lighting | 6 |
| 3 | Audit Team Statement | 8 |

Table of Figures

Figure 1 – Audit Locations Plan

Figure 2 – Problem Location Plan

Appendices

Appendix A – Documents forming the Audit Brief

1 Introduction

- 1.1.1 Royal HaskoningDHV has been appointed by Scottish PowerRenewables to undertake a Stage 1 Road Safety Audit. This Audit refers to the construction access points and haul road crossings of the existing highway network for the proposed East Anglia TWO project. The locations of the 13 accesses audited are shown on **Figure 1** of this report.
- 1.1.2 The Audit Team for this Stage 1 Road Safety Audit was as follows:
- Audit Team Leader**
Vicky Seaton, BSc (Hons), MSoRSA, MCIHT, HE CoC
HaskoningDHV UK Limited
- Audit Team Member**
Bryn Buck, MIHE
HaskoningDHV UK Limited
- 1.1.3 The Road Safety Audit took place at the Birmingham office of Royal HaskoningDHV on Thursday 4th July, in accordance with information provided by Sam Taylor of Royal HaskoningDHV's Peterborough office. The Road Safety Audit comprised an examination of the documents listed in **Appendix A** of this report.
- 1.1.4 A site visit by the above Audit Team was undertaken on Wednesday 3rd July between 14:00 and 16:30. Weather conditions during the site visit were fine and surface conditions were dry.
- 1.1.5 The terms of reference for the Road Safety Audit are described in GG 119¹. The Road Safety Audit has examined and reported only on the road safety implications of the scheme as presented and has not examined or verified the compliance of the design to any other criteria.
- 1.1.6 The Audit is concerned with 13 proposed accesses and haul road crossings and their interface with the existing public highway network. The access strategy for the proposed East Anglia TWO project includes both accesses and crossings. The accesses provide for access and egress to and from the existing public highway, whilst crossings would only permit construction traffic to cross from one side of the existing public highway to the other. No construction access or egress would be permitted from the crossing points.
- 1.1.7 Access 13 would also provide a permanent access to the onshore substation and National Grid substation and would therefore remain for the operational life of the proposed East Anglia TWO project.
- 1.1.8 The locations of any problems observed by the Audit Team are shown on **Figure 2** of this report.
- 1.1.9 A summary of Personal Injury Collision (PIC) data has been provided to the Audit Team as part of the completed Audit Brief. The PIC data identified collisions within the study area for the period between 1st February 2013 and 1st February 2018 inclusive.
- 1.1.10 The collision data indicates that two 'slight' collisions were recorded on the B1069 within proximity of Accesses and 10. The first 'slight' collision was due to a loss of control on the bend and the

¹ GG 119 Road Safety Audit (Formerly HD 19/ 15), Revision 1, January 2019

second 'slight' collision was due to reduced visibility as a result of glare from the sun. No other collisions were recorded within proximity of the remaining 11 accesses/ crossings.

- 1.1.11 Any recommendations included within this report should not be regarded as being prescriptive design solutions to the problems identified. They are only to indicate a proportionate and viable means of eliminating or mitigating the identified problem, in accordance with GG 119, and in no way imply that a formal design process has been undertaken.
- 1.1.12 There may be alternative measures of addressing a problem which would be equally acceptable or superior in achieving the desired degree of mitigation and these should be considered when responding to this report.

2 Matters Arising from this Stage 1 Road Safety Audit

2.1.1 It is understood that the design is currently only at a planning stage, and as such there are a number of items the Audit Team would wish to see but which are not expected to be available for Audit at this stage. It is recognised that these details may not be available for Audit at this time. As such, the Design Team should submit a full Stage 2 Road Safety Audit alongside the detailed design package issued to the Local Highway Authority for approval.

2.1.2 Items to be considered by the detailed design may include:

- Drainage;
- Landscaping;
- Public utilities;
- Paving and kerbing;
- Carriageway markings;
- Road signs; and
- Lighting.

B1 Local Alignment

B1.1 Visibility

B1.1.1 Problem 1

Location: Access 5 from the B1122 Aldeburgh Road.

Summary: Stationary buses could restrict forward visibility of oncoming vehicles for drivers egressing from Access 5, leading to the potential for collisions.

Description: An existing bus stop is located to the south of the existing access to Aldringham Court. When a bus is stationary at the bus stop the forward visibility of vehicles from the north (travelling south) from Access 5 would be restricted by the stationary bus. Reduced visibility, due to the stationary bus could lead to vehicles pulling out of Access 5 into the path of an oncoming vehicle, potentially leading to side impact collisions.

RECOMMENDATION

Relocate the existing bus stop to ensure it is located outside of the proposed visibility splay.

B1.2 New/ Existing Road Interface

B1.2.1 Problem 2

Location: Access 1 from Sizewell Gap road.

Summary: Accelerated wear of the carriageway could result in premature highway failure leading to the potential for potholes to form which could destabilise cyclists and motorcyclist leading to personal injury.

Description: The Audit Team observed cracking of the existing highway in the vicinity of Access 1. The addition of turning HGV traffic at this location could lead to an acceleration of the wear of the carriageway surface and the potential for the carriageway to 'pick out' and potholes to form. If cyclists or motorcyclists were to collide with these potholes the rider could be destabilised, potentially leading to a fall and personal injury.



Looking west along Sizewell Gap road, an example of existing carriageway failure

RECOMMENDATION

Resurface/ repair the carriageway opposite Access 1 to prevent premature failure of the carriageway.

B2 General

B2.1 Departures from Standard

2.1.3 The Audit Team has not been made aware of any Departures from Standard at this Stage.

B2.2 Landscaping

B2.2.1 Problem 3

Location: Accesses 1, 7, 8, 9, 10, 11, 12 and 13.

Summary: Poor maintenance of existing vegetation alongside the highway could reduce the distance drivers can see an oncoming vehicle from new points of access, leading to the potential for side impact collisions.

Description: There are existing hedgerows and trees located alongside the road in the vicinity of Accesses 1, 3, 4, 7, 8, 9, 10, 11, 12 and 13. If these hedgerows are not regularly maintained, there is the potential for the vegetation to obscure visibility of oncoming vehicles. Reduced visibility, due to overgrown vegetation could lead to vehicles pulling out of the accesses in to the path of an oncoming vehicle, potentially leading to side impact collisions.

RECOMMENDATION

Ensure that visibility splays are maintained.

B2.3 Public Utilities/ Services Apparatus

B2.3.1 Problem 4

Location: Multiple locations as follows:

- Access 3 to the north of the B1353;
- Access 8 to the west of Sloe Lane; and
- Access 10 to the west of the B1069 Snape Road.

Summary: Insufficient offsets from existing telegraph poles to turning vehicles could lead to collisions.

Description: Telegraph poles are currently installed alongside the road in the proximity of Accesses 3, 8 and 10. It is not clear from the drawings provided to the Audit Team where the access would be located in relation to the telegraph poles. The Audit Team therefore considers that there is a risk that vehicles manoeuvring into or out of the proposed accesses could collide with the telegraph pole. Furthermore, it is not clear if larger vehicles could safely pass under the cables.

RECOMMENDATION

Ensure that the final access designs include for appropriate offsets between the new accesses and existing telegraph poles. In addition, ensure that all types of vehicles can pass safely under the cables.

B3 Junctions

2.1.4 The Audit Team did not identify any junction related safety problems at this stage.

B4 Walking, Cycling and Horse Riding

2.1.5 The Audit Team did not identify any walking, cycling and horse-riding related safety problems at this stage.

B5 Traffic Signs, Carriageway Markings and Lighting

B5.1 Traffic Signs

B5.1.1 Problem 5

Location: Access 1 from Sizewell Gap road.

Summary: Insufficient offsets between an existing sign and turning vehicles could lead to collisions.

Description: A shared use footway/ cycleway sign is currently installed alongside the road in the proximity of Access 1. It is not clear from the drawings provided to the Audit Team where the access would be located in relation to the sign. The Audit Team therefore considers that there is a risk that vehicles turning into or out of the proposed accesses could collide with the sign.

RECOMMENDATION

Ensure that the final access design includes for an appropriate offset between the new access and existing sign.

B5.1.2 Problem 6

Location: Accesses 1 and 2 from Sizewell Gap road.

Summary: Temporary signage located within the existing footway/ cycleway along Sizewell Gap Road could reduce the effective width leading to collisions.

Description: Temporary signing arrangements are proposed in the vicinity of Access 1 and Access 2. If positioned within the existing shared use footway/ cycleway the signs could reduce the effective width leading to the potential for conflict and collisions between pedestrians and cyclists.

RECOMMENDATION

Ensure that the final sign locations do not impact upon the effective width of the footway/ cycleway and that mounting heights allow cyclists to pass under the signs.

B5.1.3 Problem 7

Location: Access 5 from the B1122 Aldeburgh Road.

Summary: Temporary signage located within the existing footway along Aldeburgh Road could reduce the effective width leading to collisions.

Description: Temporary signing arrangements are proposed in the vicinity of Access 5. If positioned within the existing footway, the signs could reduce the effective width. A reduced footway width could potentially force users with pushchairs or in wheelchairs and mobility scooters to have to take to the road to navigate around the signs. Users travelling in the road could be struck by passing vehicles.

RECOMMENDATION

Ensure that the final sign locations do not impact upon the effective width of the footway.

B5.1.4 Problem 8

Location: Access 6 from the B1069 Snape Road.

Summary: An existing 'Elderly people' crossing sign could restrict visibility for drivers departing from Access 6, potentially leading to side impact collisions.

Description: An existing 'Elderly people' crossing sign is located to the south of Aldringham Court. The existing sign would be located within the visibility splay for Access 6, potentially reducing the forward visibility of oncoming vehicles. Reduced forward visibility from Access 6 could result in vehicles pulling out of the access across the path of an oncoming vehicle, leading to side impact collisions.

RECOMMENDATION

Relocate the existing 'Elderly people' crossing sign away from the visibility splay or raise the height of the sign assembly to allow drivers to see approaching vehicles under the sign face.

B5.1.5 Problem 9

Location: Multiple locations as follows:

- Accesses 7 and 8 from Sloe Lane;
- Accesses 11 and 12 from the B1069 Snape Road; and
- Access 13 from B1121 Saxmundham Road.

Summary: New signs placed close to the edge of the highway or within highway could be vulnerable to collisions with passing vehicles.

Description: Temporary signage is proposed on the approach to all new accesses. The existing highway and verges on the approach to Accesses 7, 8, 11, 12 and 13 are narrow, this could result in signs being placed within or close to the edge of the highway. Signs placed close to or within the highway could lead to collisions between vehicles and the sign or head on collisions between vehicles as drivers stray into the oncoming lane to avoid the signs.

RECOMMENDATION

Ensure that the final sign designs consider the available verge width maintaining a minimum 450mm clearance from the edge of the road to the edge of the sign face.

B5.2 Carriageway Markings

B5.2.1 Problem 10

Location: Access 13 from the B1121 Saxmundham Road.

Summary: The existing centre line markings along the B1121 Saxmundham Road finish short of Access 13. A centre line would reduce the potential for drivers departing from Access 13 to stray into the oncoming lane.

Description: An existing carriageway centre line is provided to the south of the proposed Access 13 in the vicinity of the junction with Kiln Lane. The centre line however terminates to the south of the proposed Access 13. The Audit Team were concerned that the presence of a centre line would assist drivers staying in lane when departing from Access 13. Without a centre line, drivers departing Access 13 may miss judge their position and stray in to the oncoming lane, potentially leading to head on collisions.

RECOMMENDATION

Extend the existing centre line to encompass Access 13.

3 Audit Team Statement

3.1.1 We certify that this Road Safety Audit has been carried out in accordance with GG 119.

Audit Team Leader

██████████ BSc (Hons), MSoRSA, MCIHT, HE CoC
Principal Transport Planner
Royal HaskoningDHV
5th Floor Newater House
11 Newhall Street
Birmingham

Signed: REDACTED

Dated: 17.07.2019

Road Safety Audit Team Member

██████████, MIHE
Senior Technician & Road Safety Auditor
Royal HaskoningDHV
9th Floor, Manchester One
Portland Street
Manchester
M1 3LF
United Kingdom

Signed: REDACTED

Date: 04.07.2019

Appendix A

Documents Forming the Audit Brief

APPENDIX A

Documents Forming the Audit Brief

DRAWING NUMBER

TP-PB4842-DR001 Rev D0.5
TP-PB4842-DR002 Rev D0.2
TP-PB4842-DR003 Rev D0.3
TP-PB4842-DR004 Rev D0.2
TP-PB4842-DR007 Rev D0.4
TP-PB4842-DR008 Rev D0.4
TP-PB4842-DR009 Rev D0.2
TP-PB4842-DR010 Rev D0.2
TP-PB4842-DR027 Rev D0.1
TP-PB4842-DR011 Rev D0.3
TP-PB4842-DR012 Rev D0.2
TP-PB4842-DR013 Rev D0.2
TP-PB4842-DR014 Rev D0.3
TP-PB4842-DR020 Rev D0.2
TP-PB4842-DR021 Rev D0.2
TP-PB4842-DR022 Rev D0.2

DRAWING TITLE

Access 1
Access 1 SPA
Access 2
Access 2 SPA
Access 3 and 4 (Crossings)
Access 5 and 6
Access 5 SPA
Access 6 SPA
Access 7 and 8 (Crossings)
Access 9 and 10
Access 9 SPA
Access 10 SPA
Access 11 and 12 (Crossings)
Access 13 (construction phase access)
Access 13 (operational phase access)
Access 13 SPA

DOCUMENTS

- Safety Audit Brief
- Site Location Plan
- Traffic signal details
- Departures from standard
- Previous Road Safety Audits
- Previous Designer Responses
- Collision data
- Collision plot
- Traffic flow / modelling data
- Pedestrian flow / modelling data
- Speed survey data

- Other documents

DETAILS (where appropriate)

Included within the audit brief

Included within the audit brief

Included on drawings

Figures

Figure 1 – Site Location Plan

Figure 2 – Problem Location Plan



Legend

- East Anglia TWO Onshore Development Area
- Access ID
- Crossing ID



| Rev | Date | By | Comment |
|-----|------------|----|--------------|
| 1 | 11/07/2019 | AB | First Issue. |

| | |
|-----------|----|
| Prepared: | AB |
| Checked: | ST |
| Approved: | AH |

1:30,000
Scale @ A3

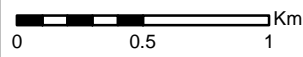

Source: © Crown copyright and database rights 2018. Ordnance Survey 0100031673.
This map has been produced to the latest known information at the time of issue, and has been produced for your information only. Please consult with the SPR Onshore GIS team to ensure the content is still current before using the information contained on this map. To the fullest extent permitted by law, we accept no responsibility or liability (whether in contract, tort (including negligence) or otherwise in respect of any errors or omissions in the information contained in the map and shall not be liable for any loss, damage or expense caused by such errors or omissions.

East Anglia TWO

Access Locations

| | |
|---------------|------------------------|
| Drg No | EA2-DEV-DRG-IBR-000741 |
| Rev | 1 |
| Date | 11/07/19 |
| Figure | 1 |

Coordinate System: BNG
Datum: OSG36

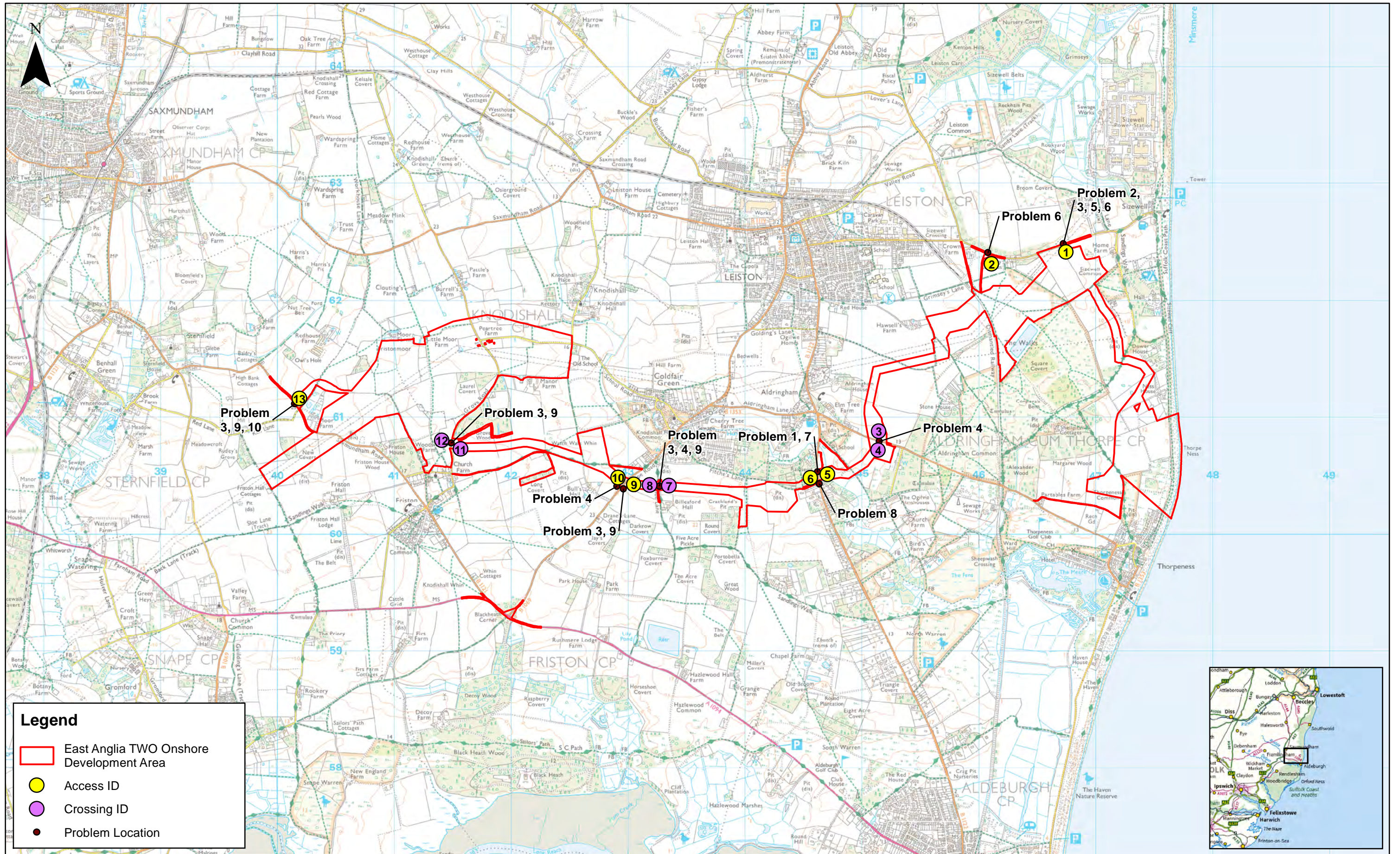

Legend

- East Anglia TWO Onshore Development Area
- Access ID
- Crossing ID
- Problem Location



| Rev | Date | By | Comment |
|-----|------------|----|--------------|
| 1 | 11/07/2019 | AB | First Issue. |

| | | |
|-----------|----|------------|
| Prepared: | AB | 1:30,000 |
| Checked: | ST | Scale @ A3 |
| Approved: | AH | 0 0.5 1 Km |

East Anglia TWO

Problem Location Plan

| | | |
|--------|------------------------|------------------------|
| Drg No | EA2-DEV-DRG-IBR-000869 | |
| Rev | 1 | Coordinate System: BNG |
| Date | 11/07/19 | Datum: OSGB36 |
| Figure | 2 | |